

組別: 3男單 預賽 3月14日
組數: 87
晉級: 29

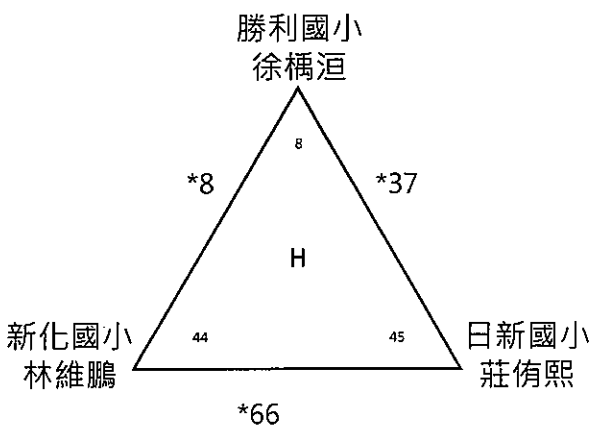

組別: 3男單 預賽 3月14日
 組數: 87
 晉級: 29

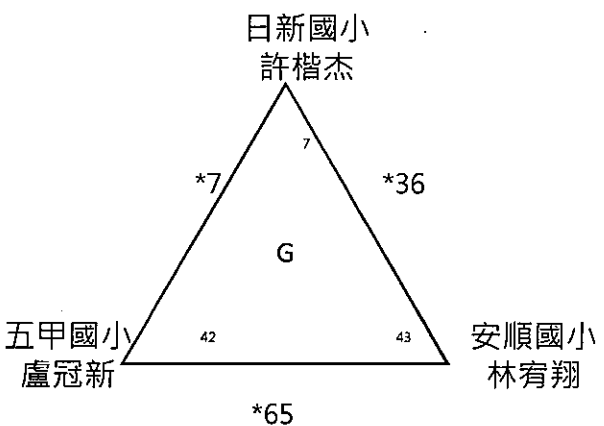
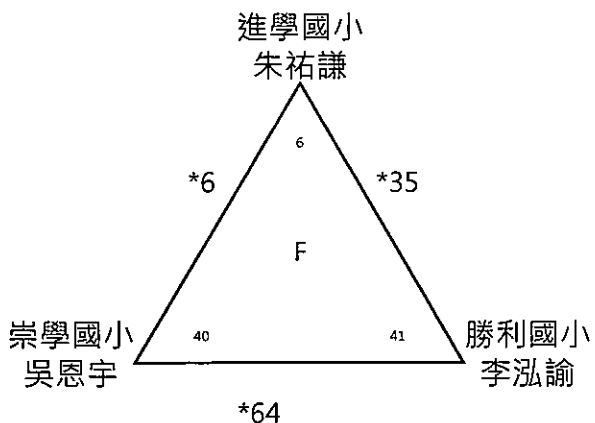
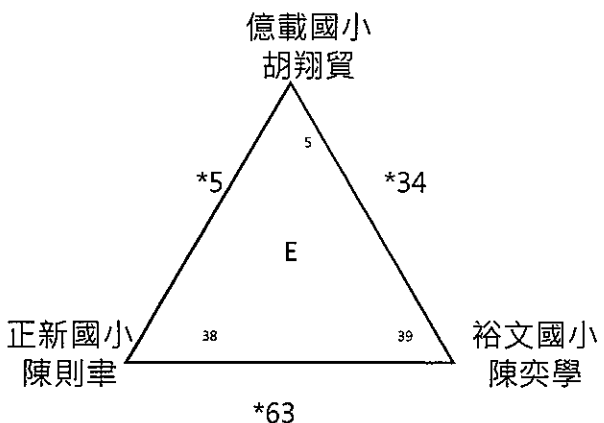
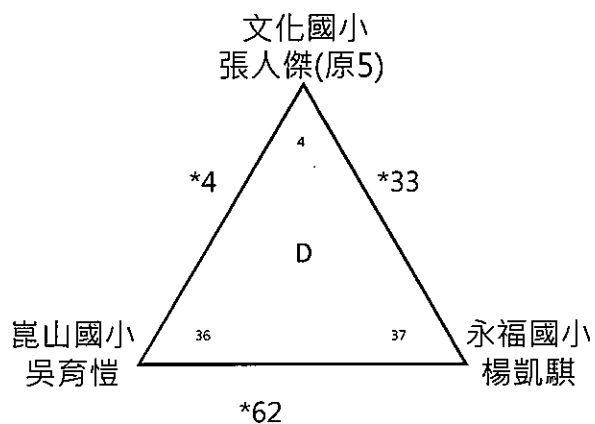
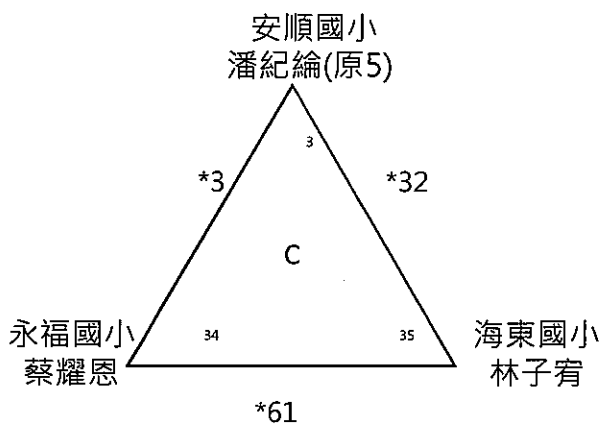
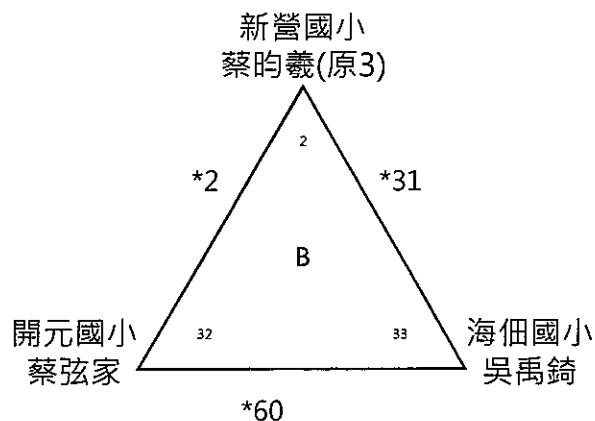
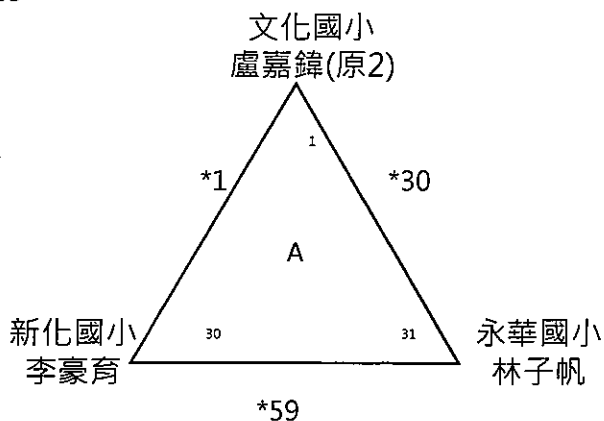
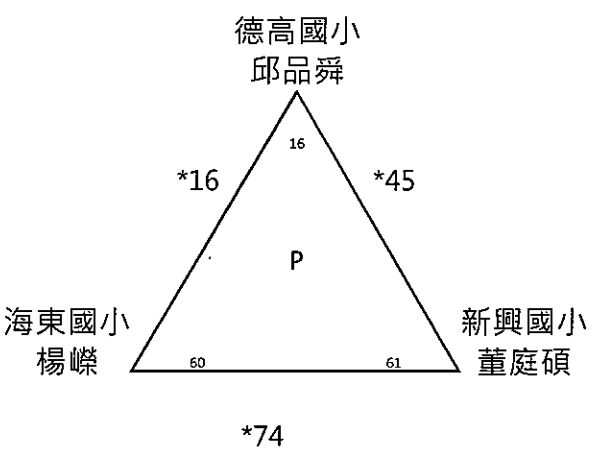
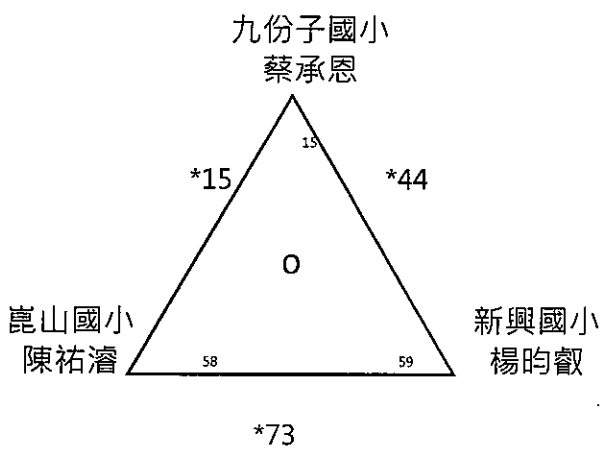
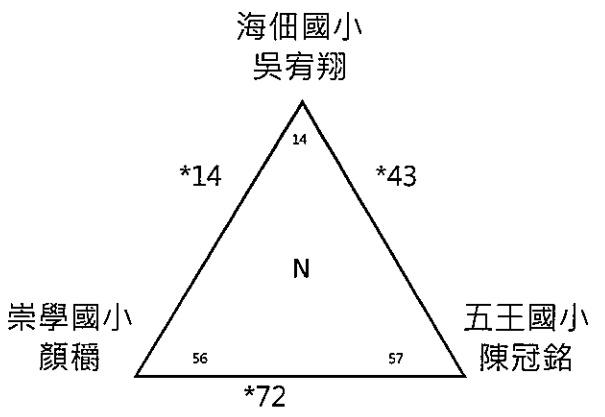
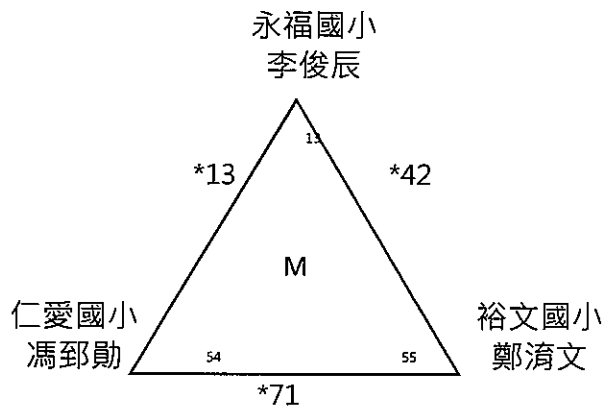
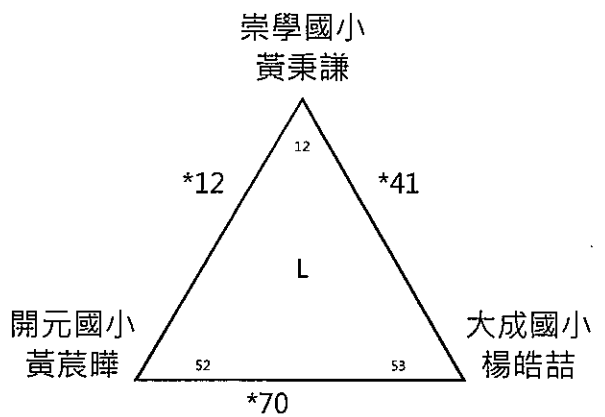
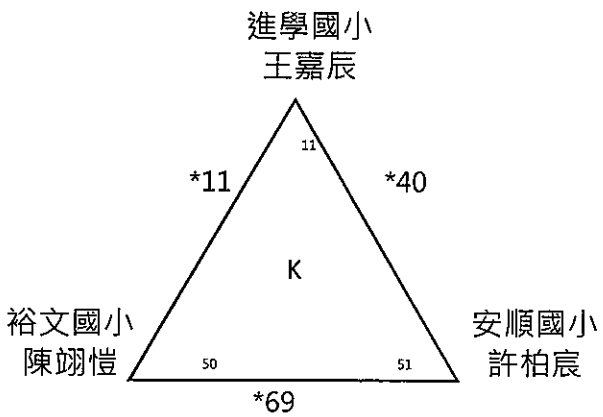
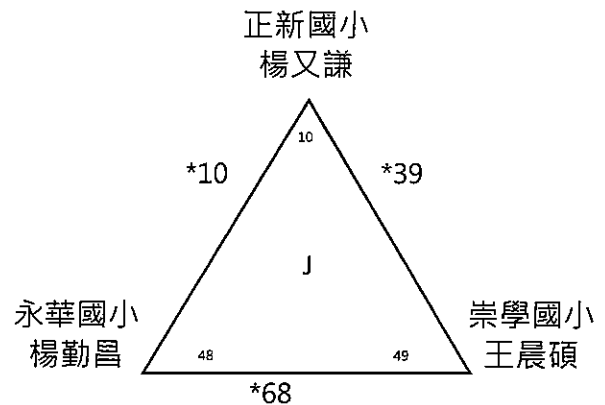
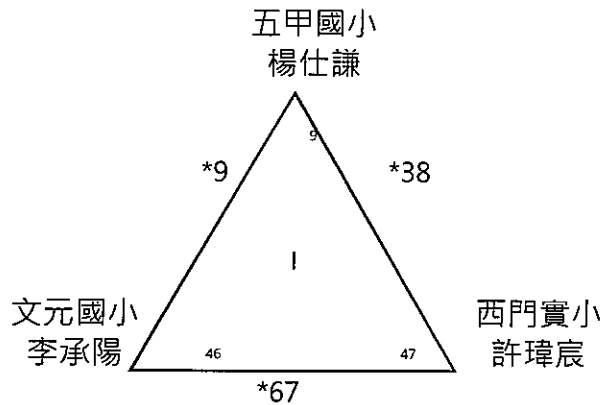

組別: 3男單 預賽 3月14日

組數: 87

晉級: 29

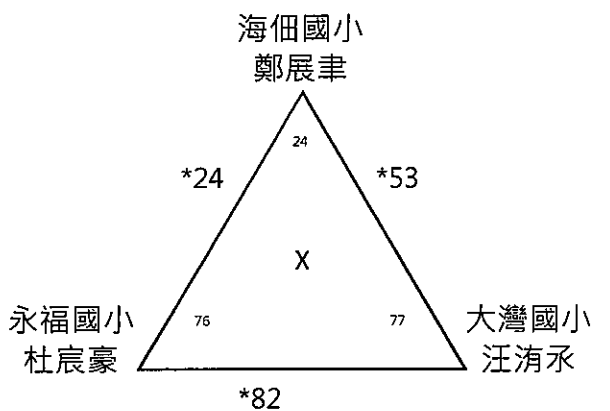
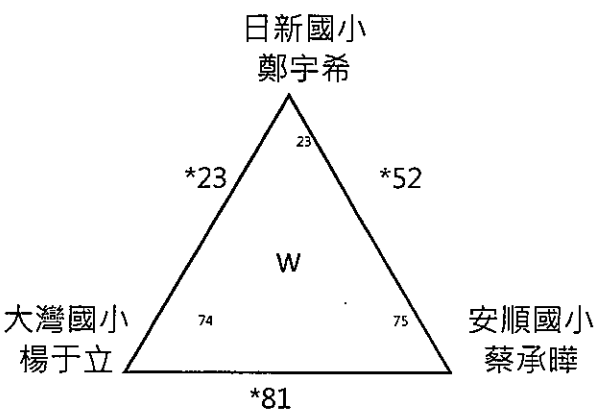
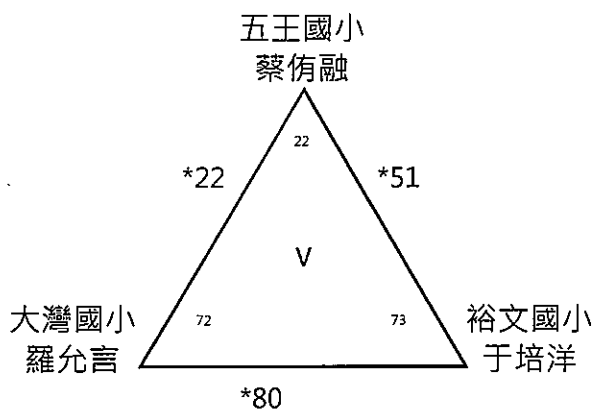
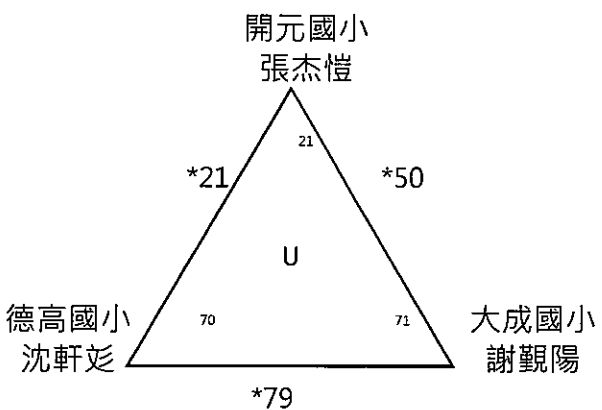
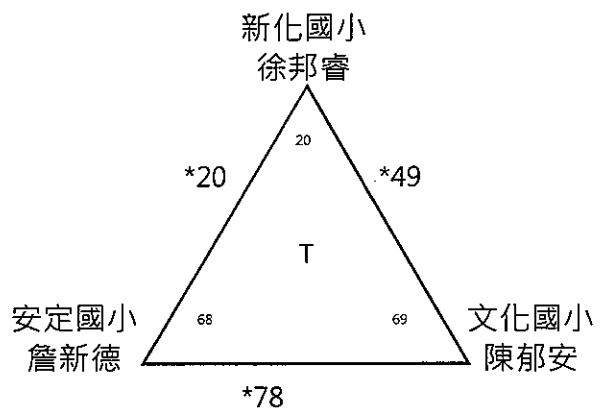
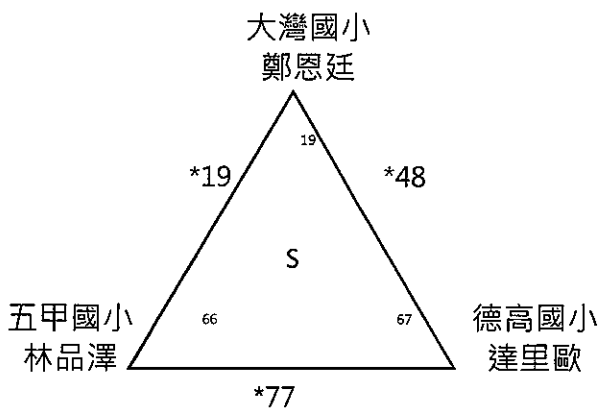
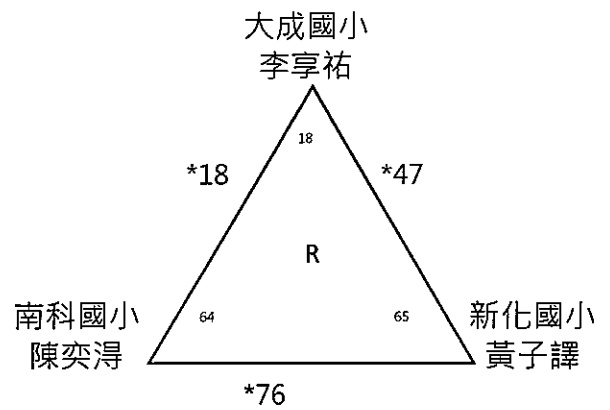
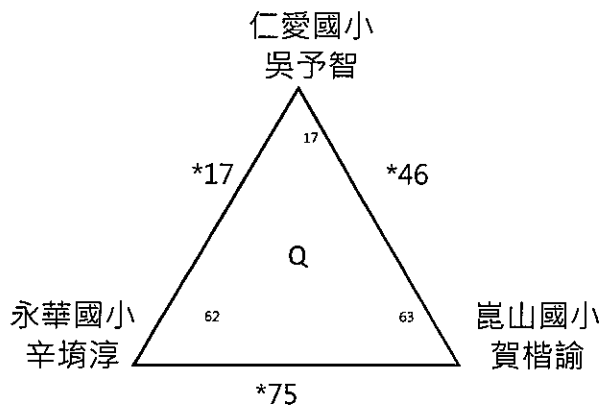

組別: 3男單 預賽 3月14日

組數: 87

晉級: 29

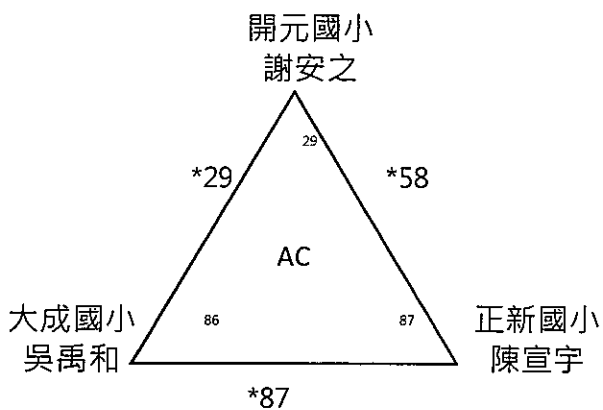
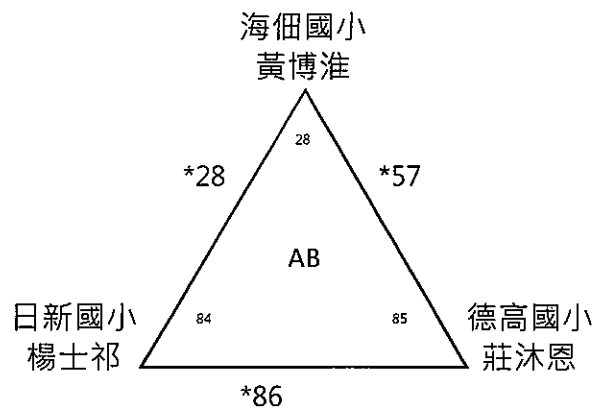
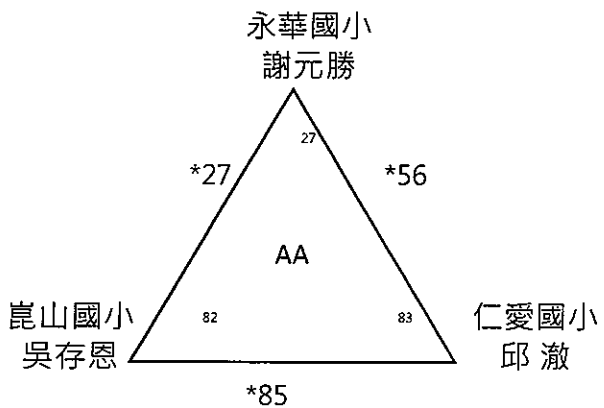
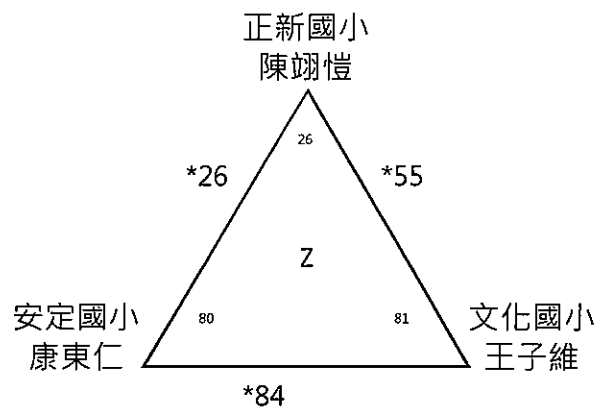
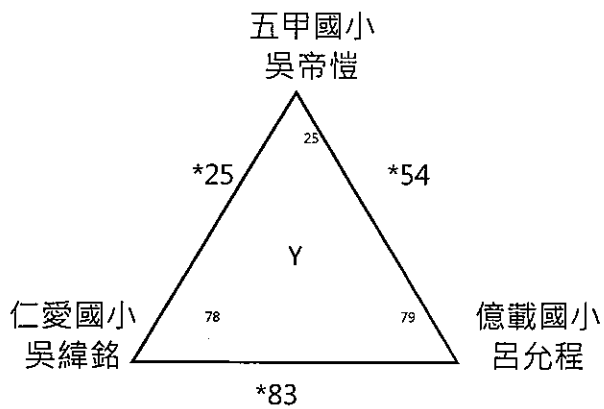

組別: 4男單 預賽 3月14日
組數: 70
晉級: 24

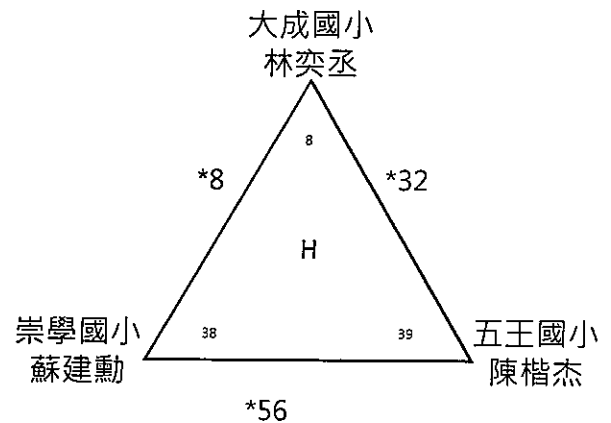
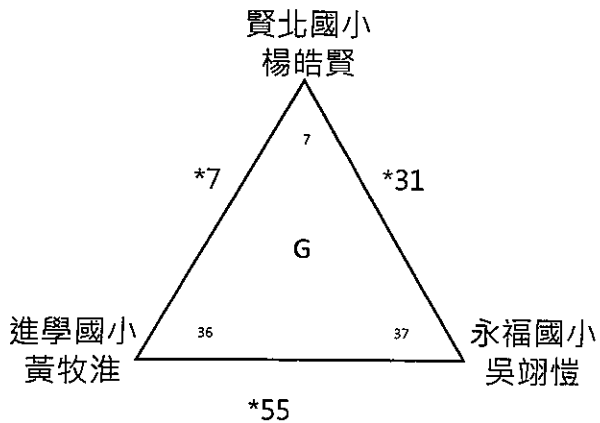
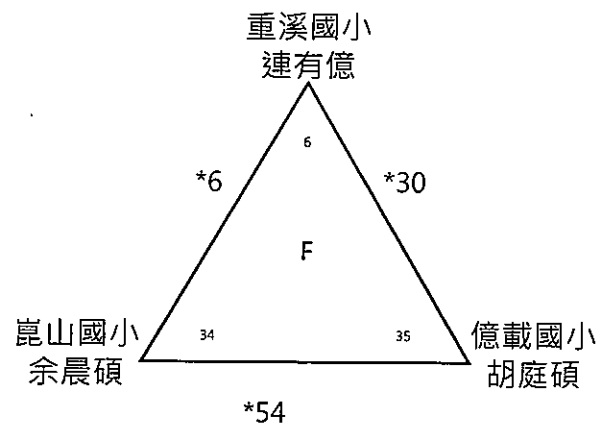
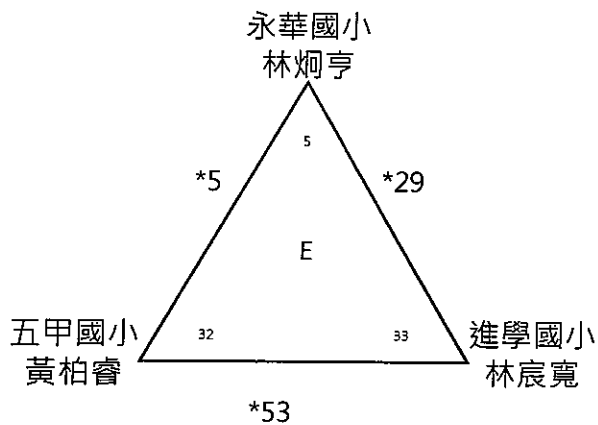
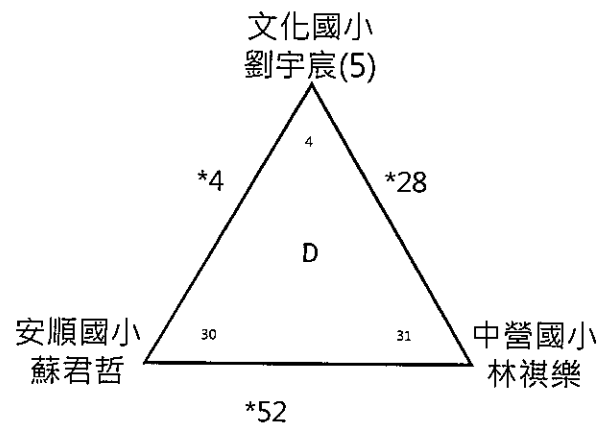
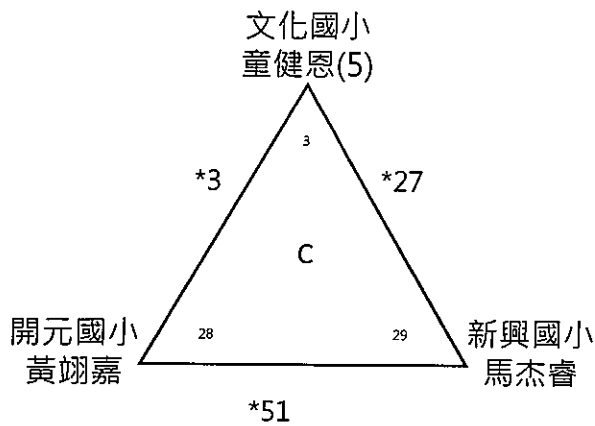
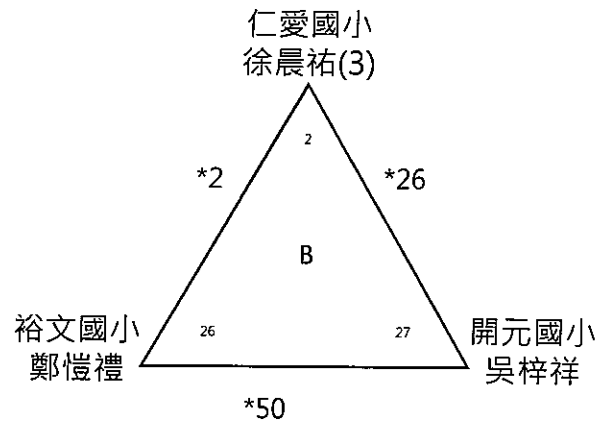
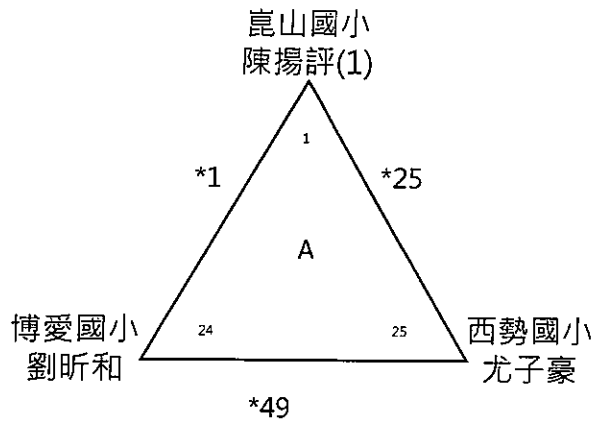

組別: 4男單 預賽 3月14日
 組數: 70
 晉級: 24

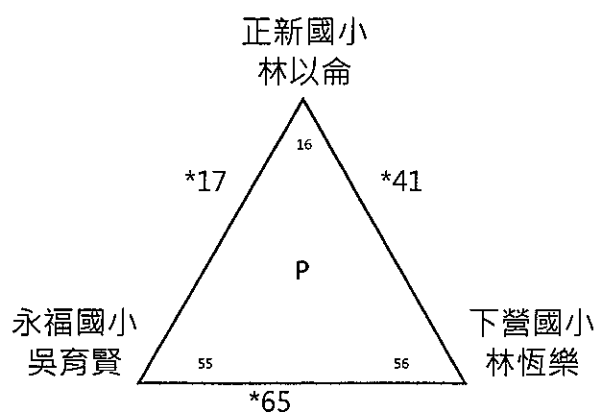
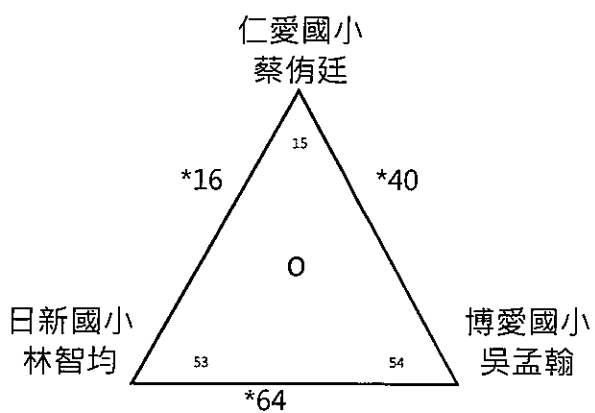
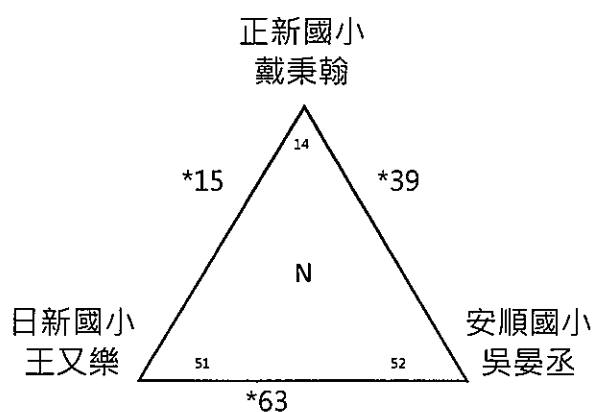
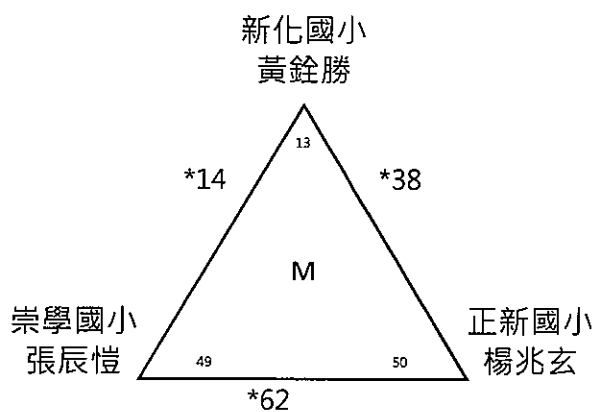
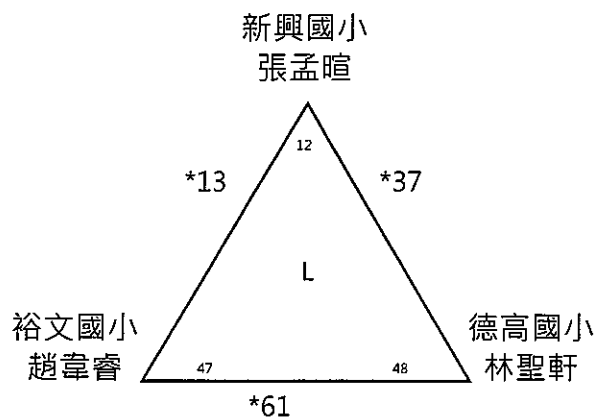
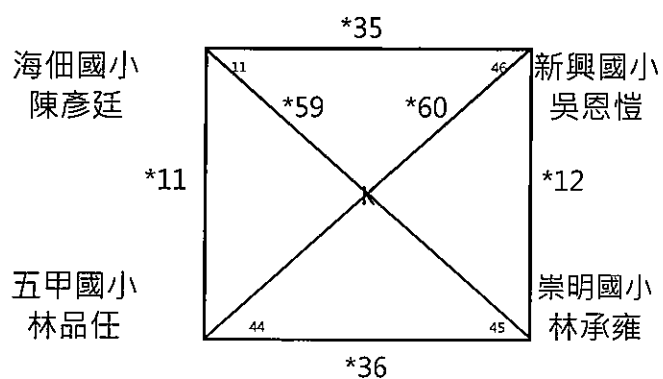
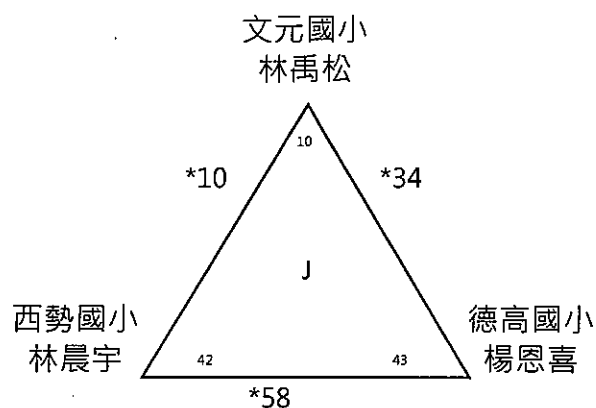
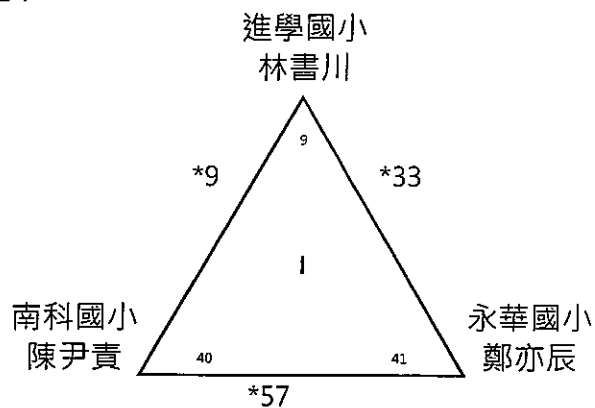

組別: 4男單 預賽 3月14日

組數: 70

晉級: 24

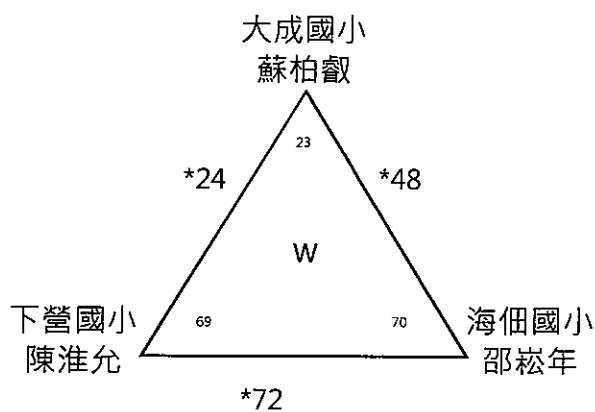
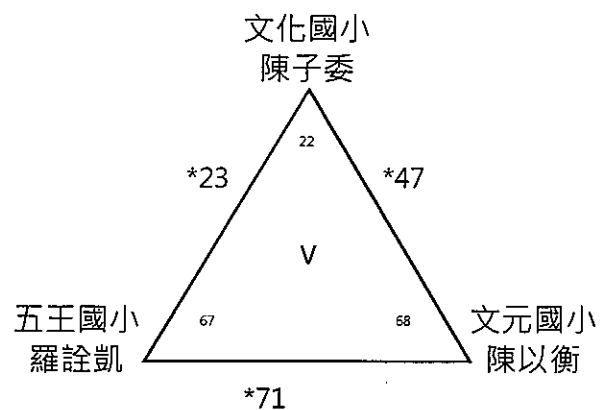
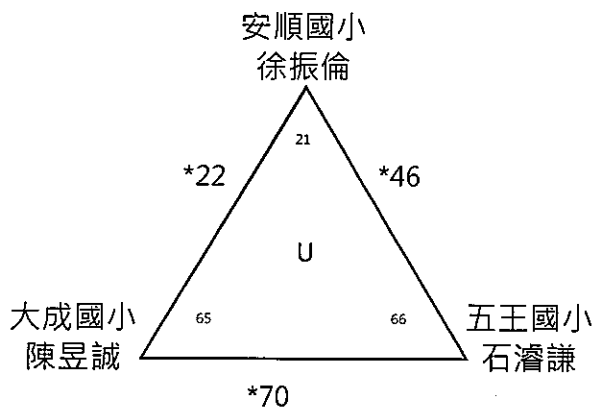
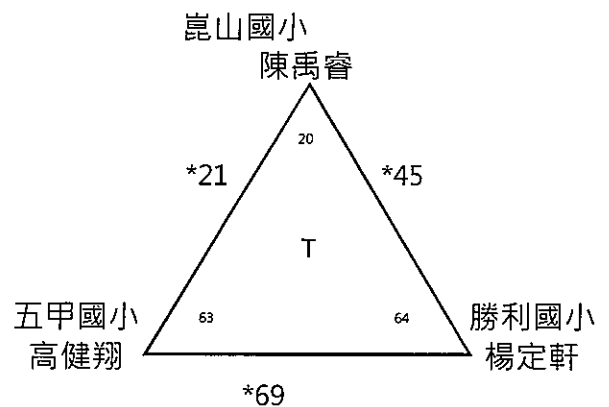
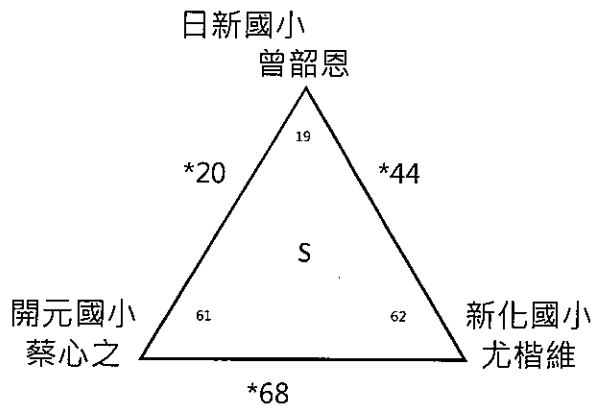
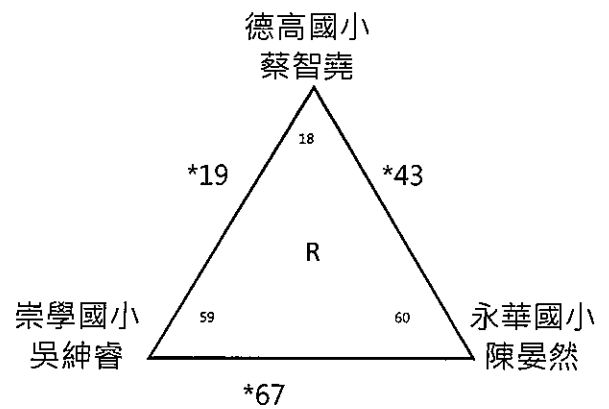
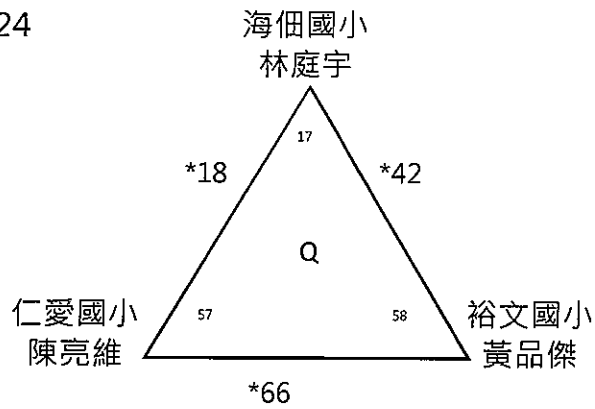

組別: 4男單決
晉級: 24

3月14日

籤號

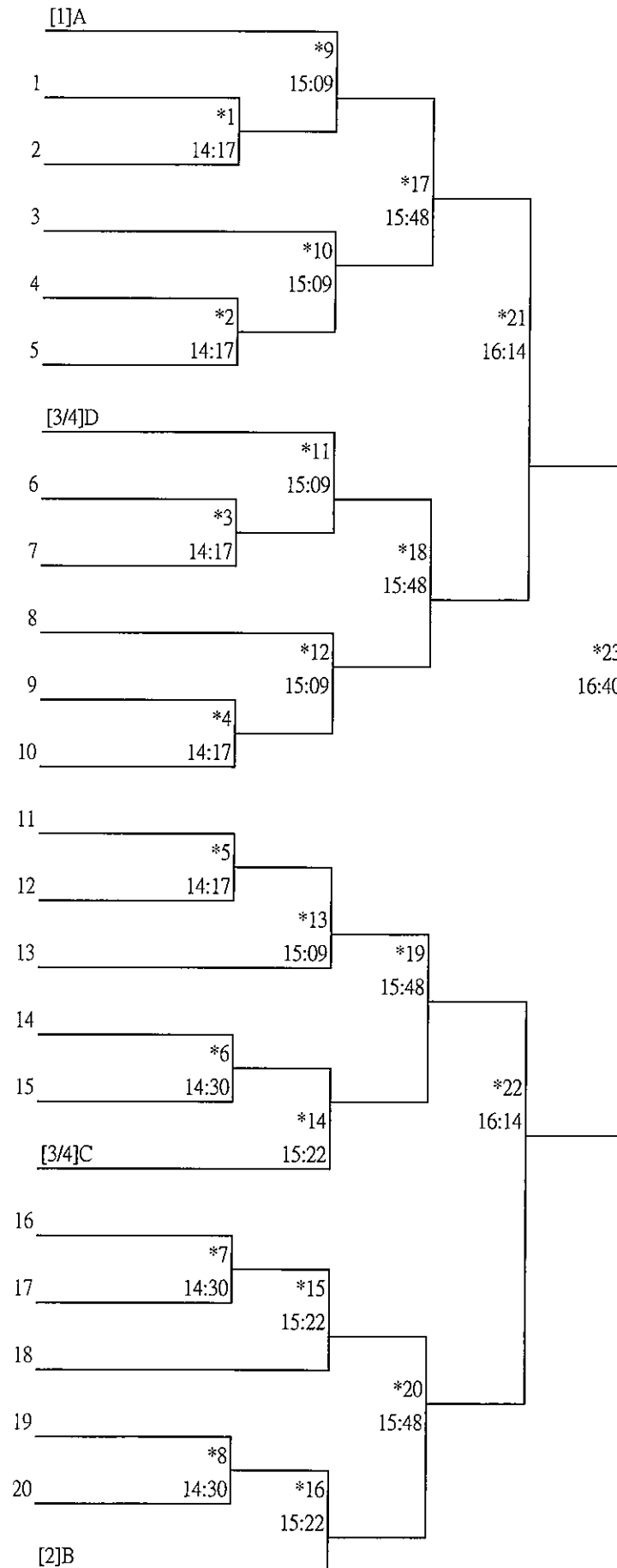

組別 5男單 預賽 3月13日
組數 52
晉級 18

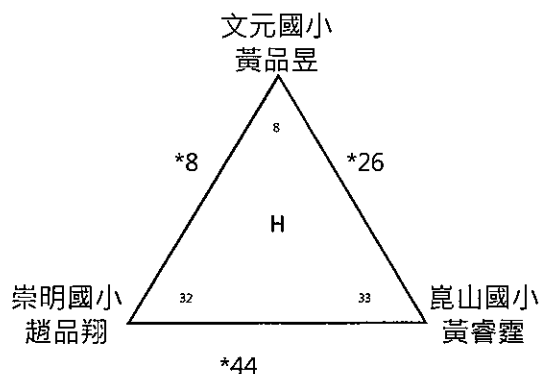
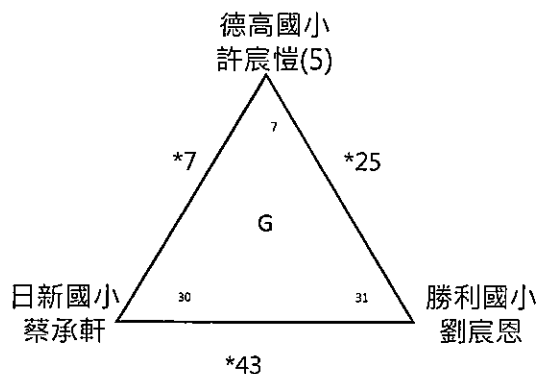
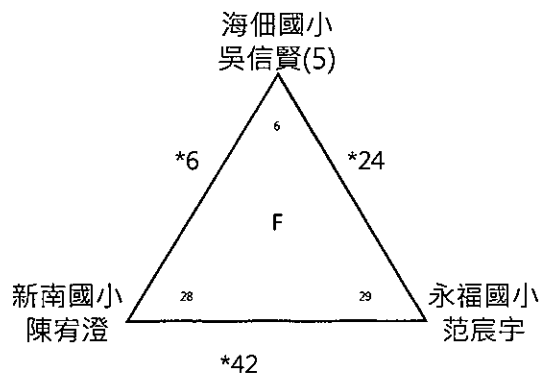
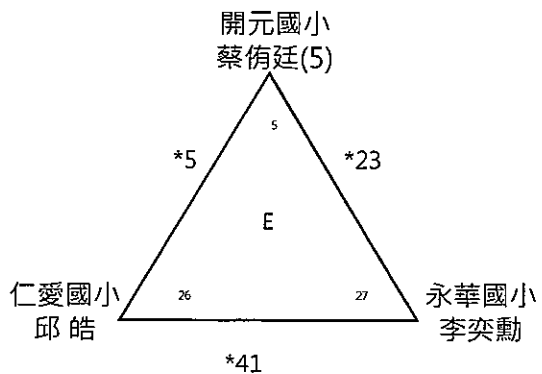
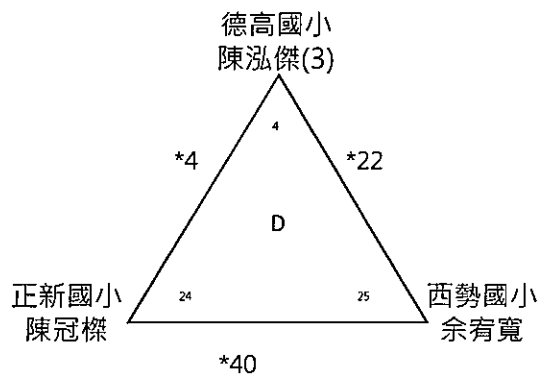
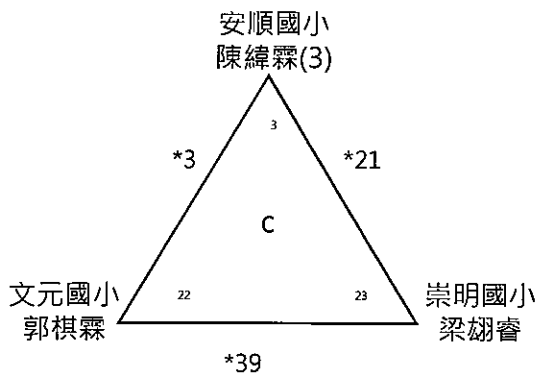
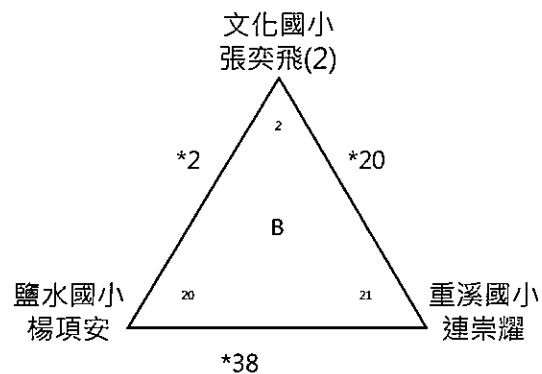
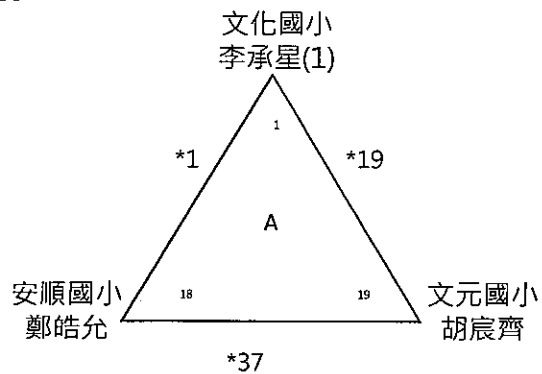

組別: 5男單 預賽 3月13日
 組數: 52
 晉級: 18

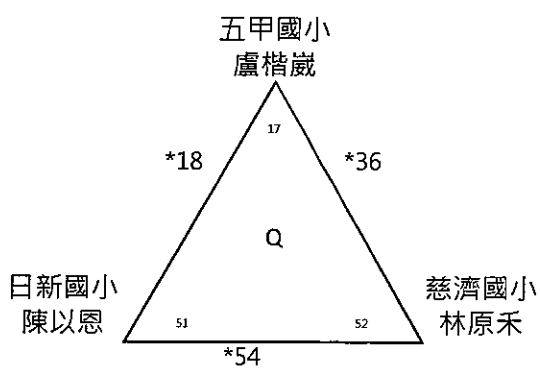
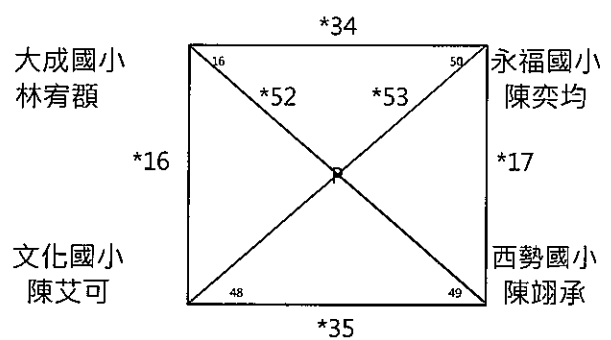
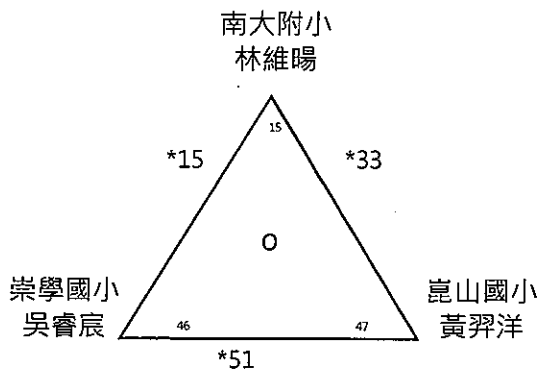
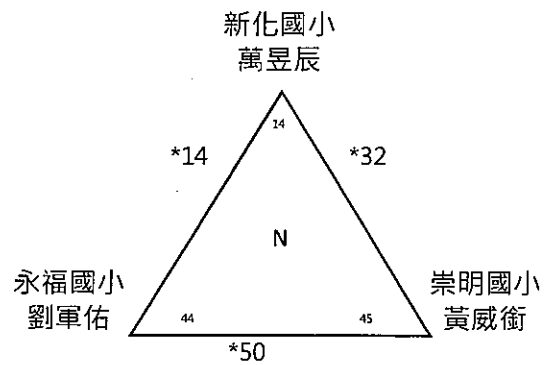
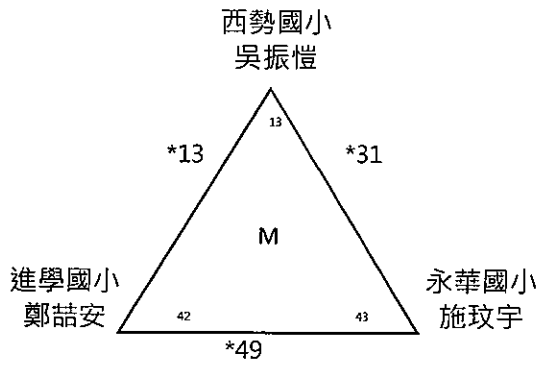
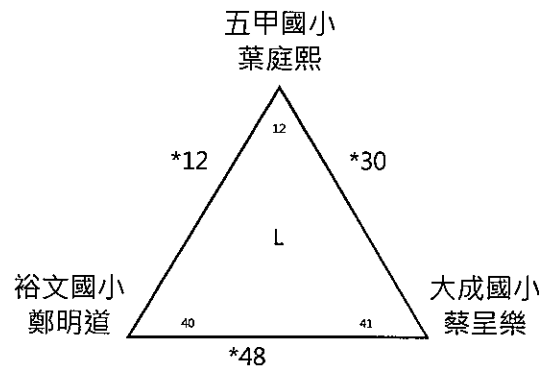
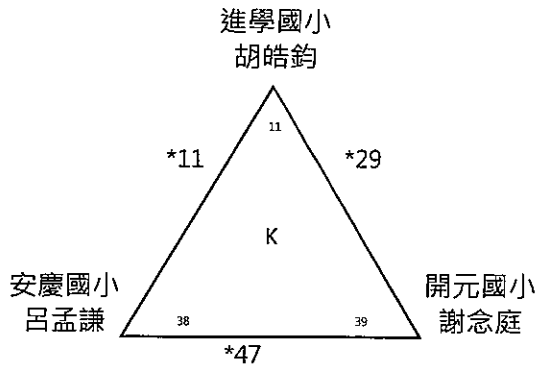
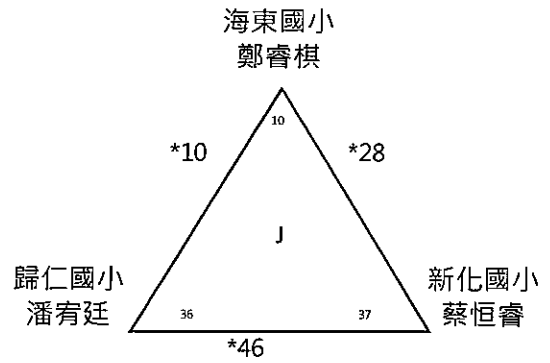
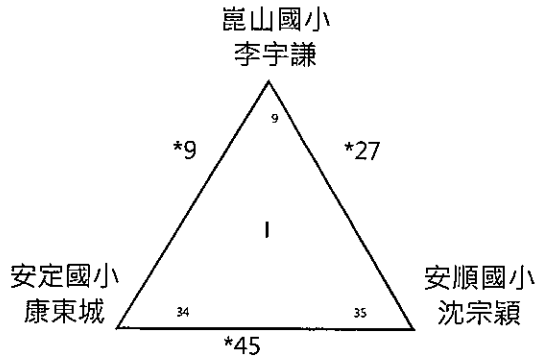

組別: 5男單決
晉級: 18

3月13日

籤號

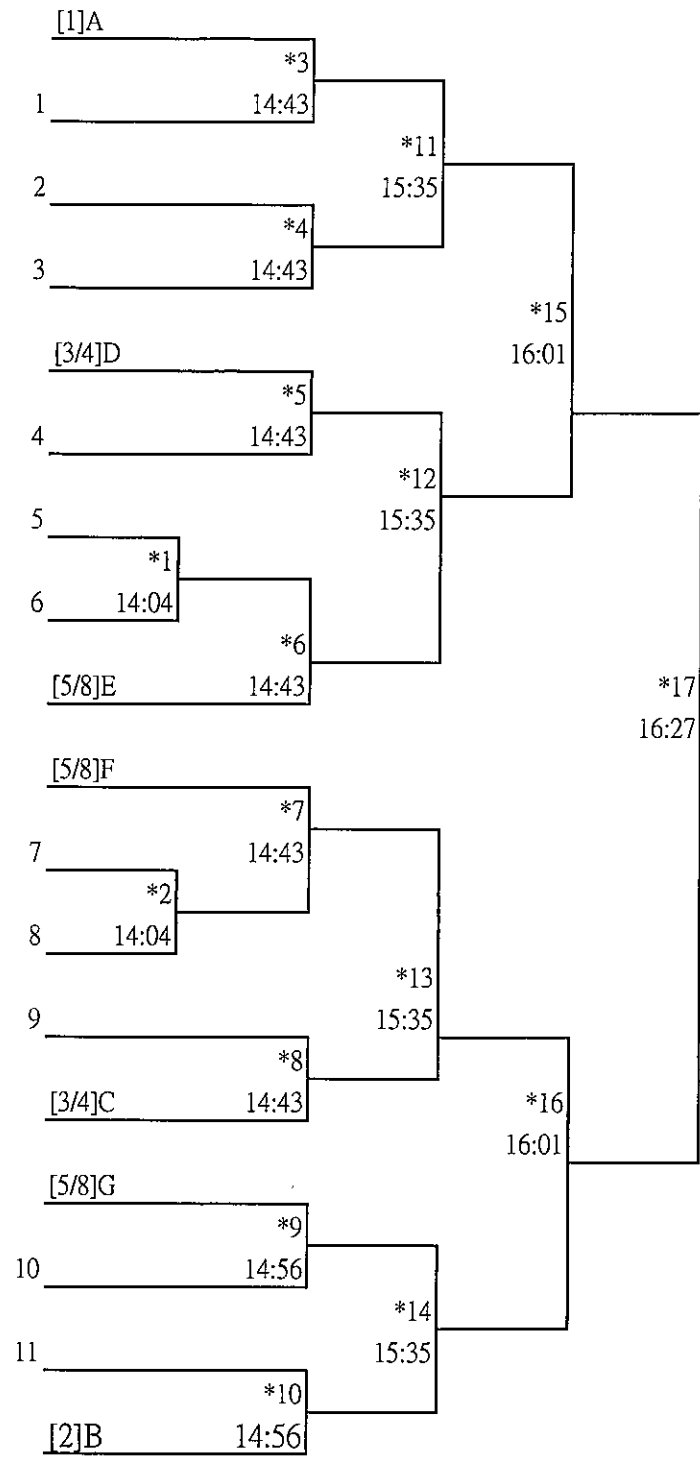

組別: 五男雙 24組,取8名

賽制:雙敗淘汰制

勝部: 3月11日

白宗翰	邱程楓	永華國小	1						
林宥成	沈熙恩	安順國小	24						
傅暉翔	楊甯文	新興國小	16	09:05					
林智謙	林語哲	永華國小	9						
邱敬宸	楊允齊	新興國小	17	09:05					
李冠霆	洪頌善	崑山國小	8						
王柏霖	張子賢	文元國小	5						
陳智均	王宸彬	崑山國小	13						
陳心寬	邱寬仁	文化國小	20	09:05					
沈泓鈞	陳燁睿	裕文國小	12						
黃于哲	鄭郁恩	文元國小	21	09:18					
許祐榕	呂宗霖	永華國小	4						
邱尚謙	邱尚廉	崑山國小	3						
徐楷喆	李侑頌	安順國小	19						
曾裕幃	李明諭	新化國小	14	09:18					
蕭宇恩	高晨碩	五甲國小	11						
呂嘉叡	陳伯維	開元國小	22	09:18					
曾柏翰	盧九伍	文化國小	6						
李品諺	謝秉謙	文化國小	7						
楊晨諭	雷沐華	億載國小	15						
沈宥程	沈宥宏	安順國小	18	09:18					
陳侑澤	龐于程	新興國小	10						
田柏佑	田柏祥	正新國小	23	09:31					
鄭翔升	許宥庠	開元國小	2						

第一名

組別: 五男雙 24組,取8名

賽制:雙敗淘汰制

敗部:

3月11日

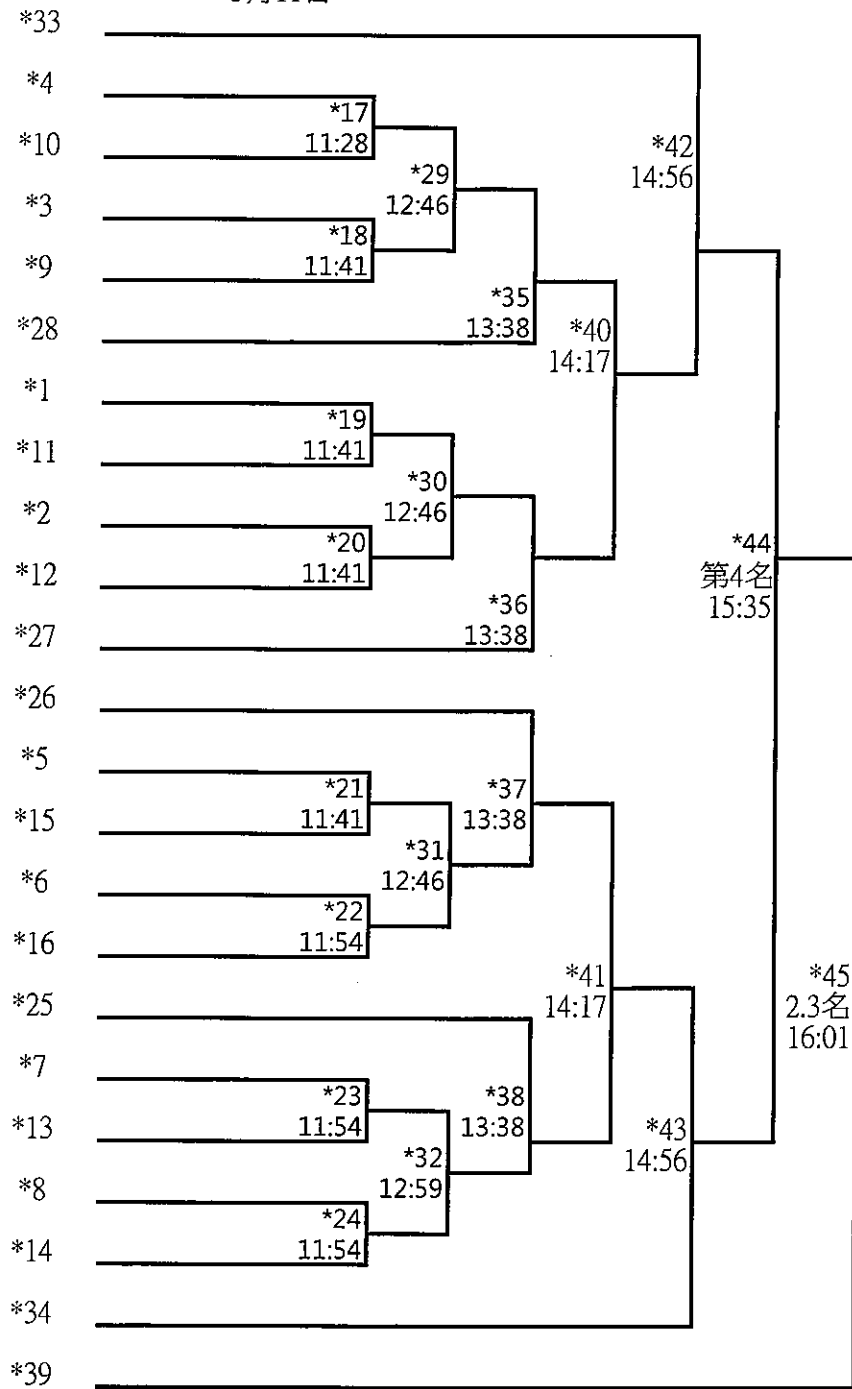

組別: 6男單 預賽 3月10日
組數: 48
晉級: 16

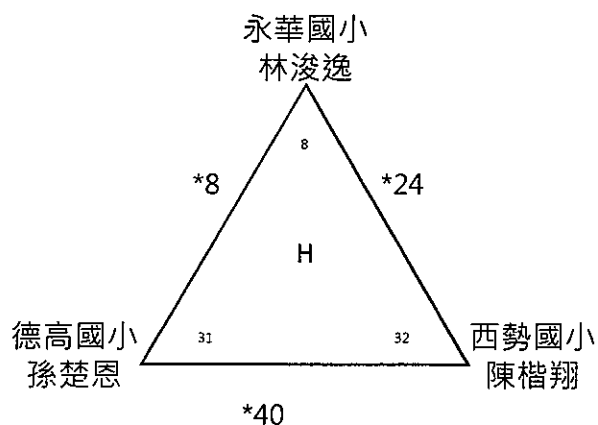
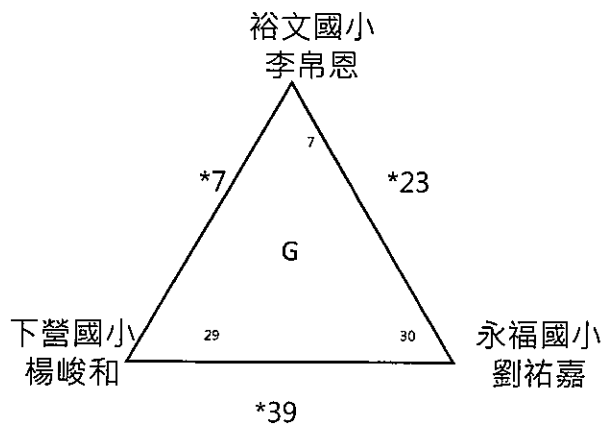
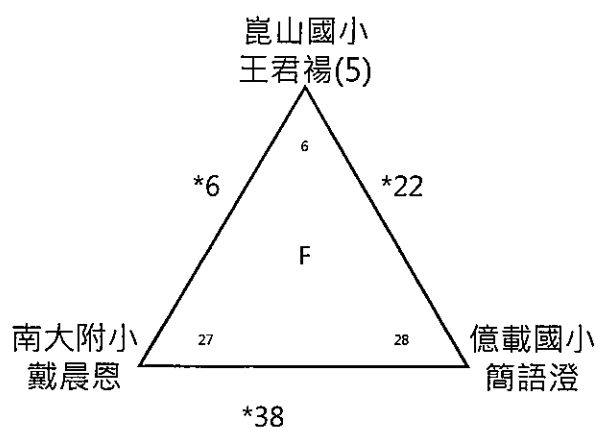
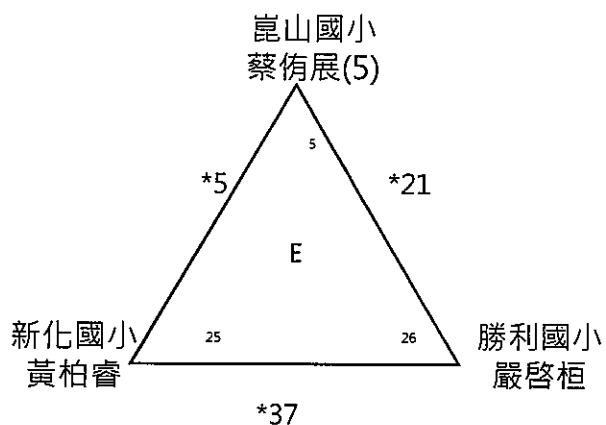
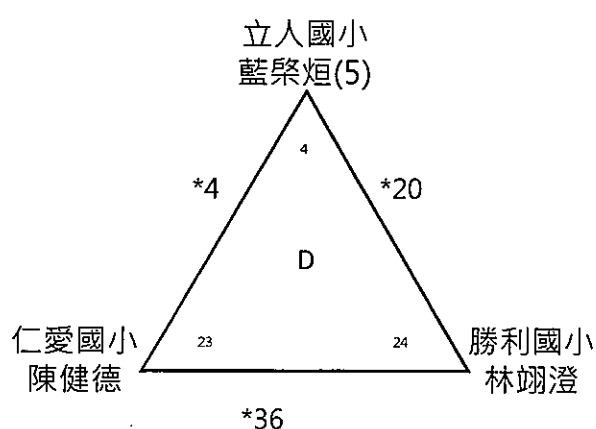
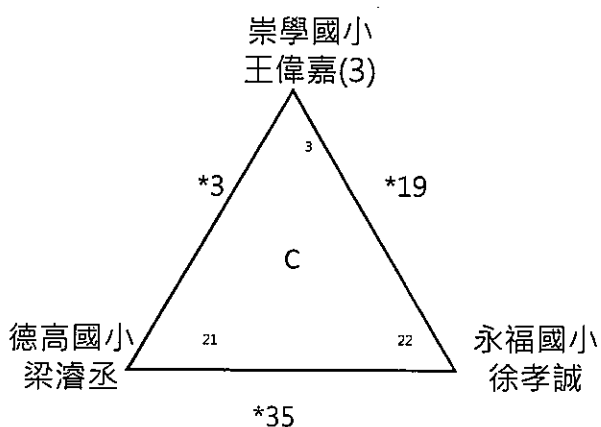
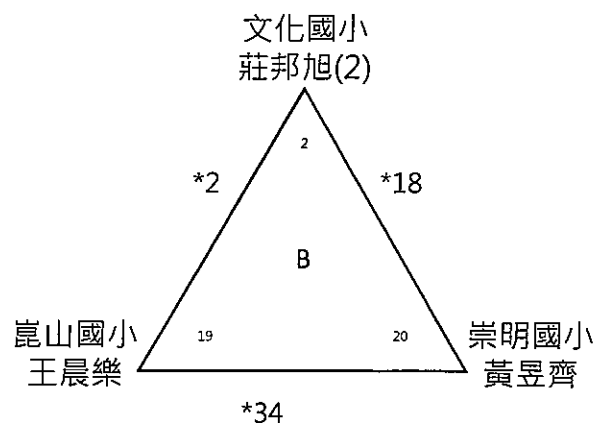
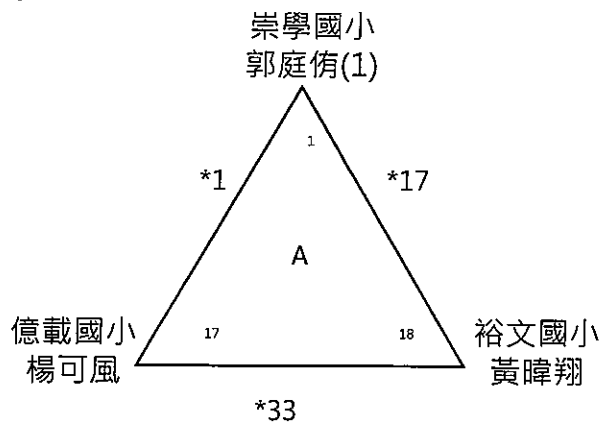

組別: 6男單 預賽 3月10日

組數: 48

晉級: 16

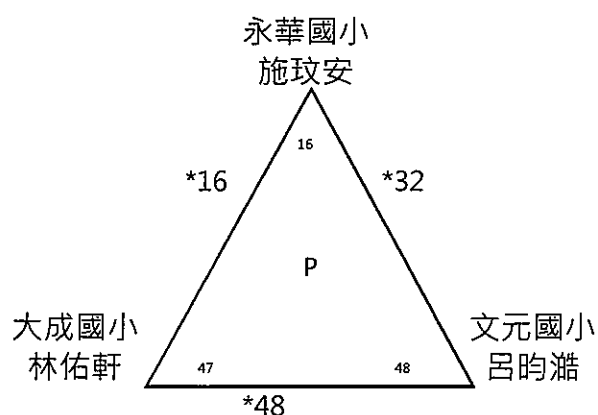
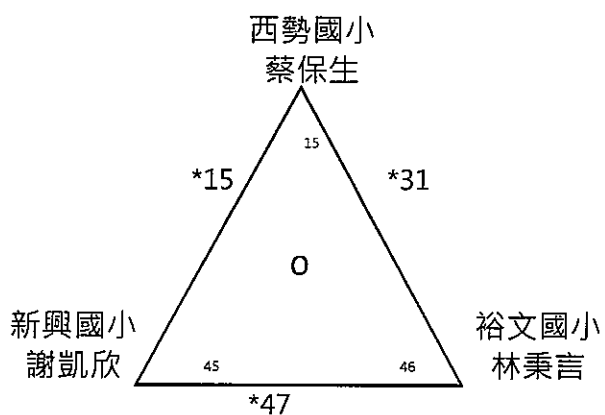
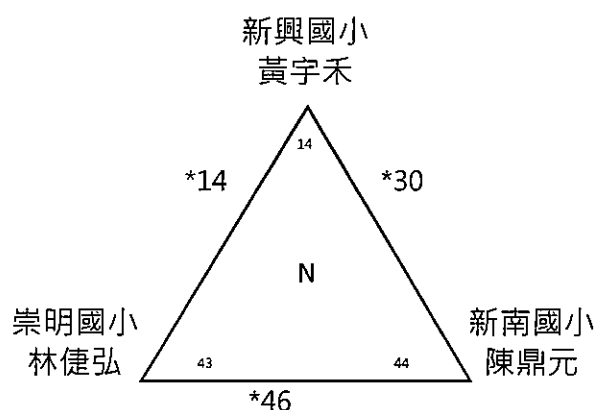
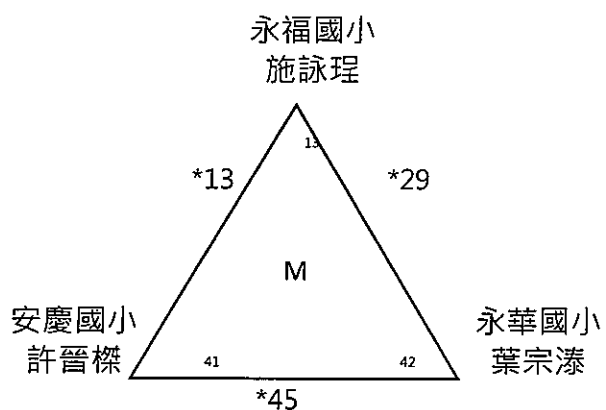
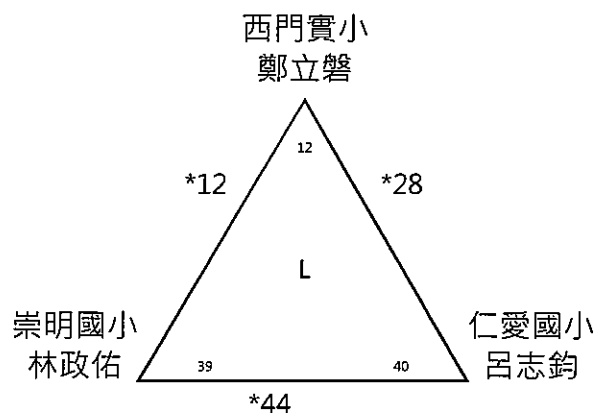
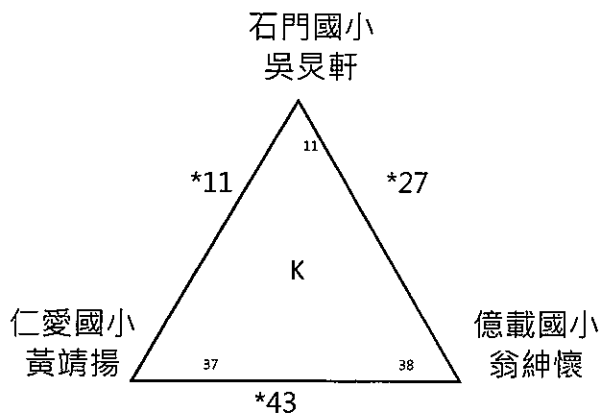
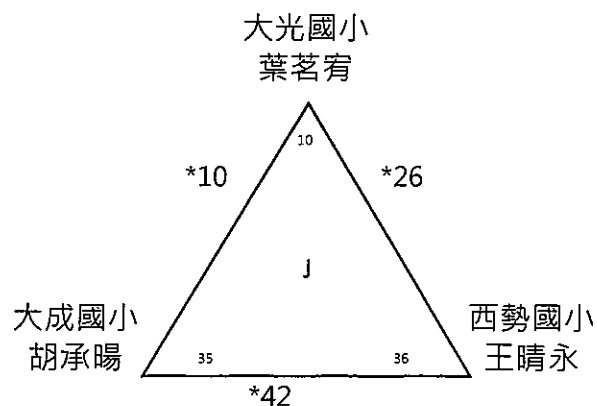
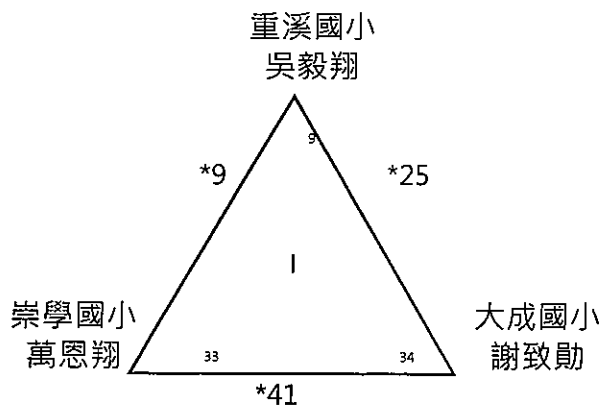

組別: 6男單決
晉級: 16

3月11日

籤號

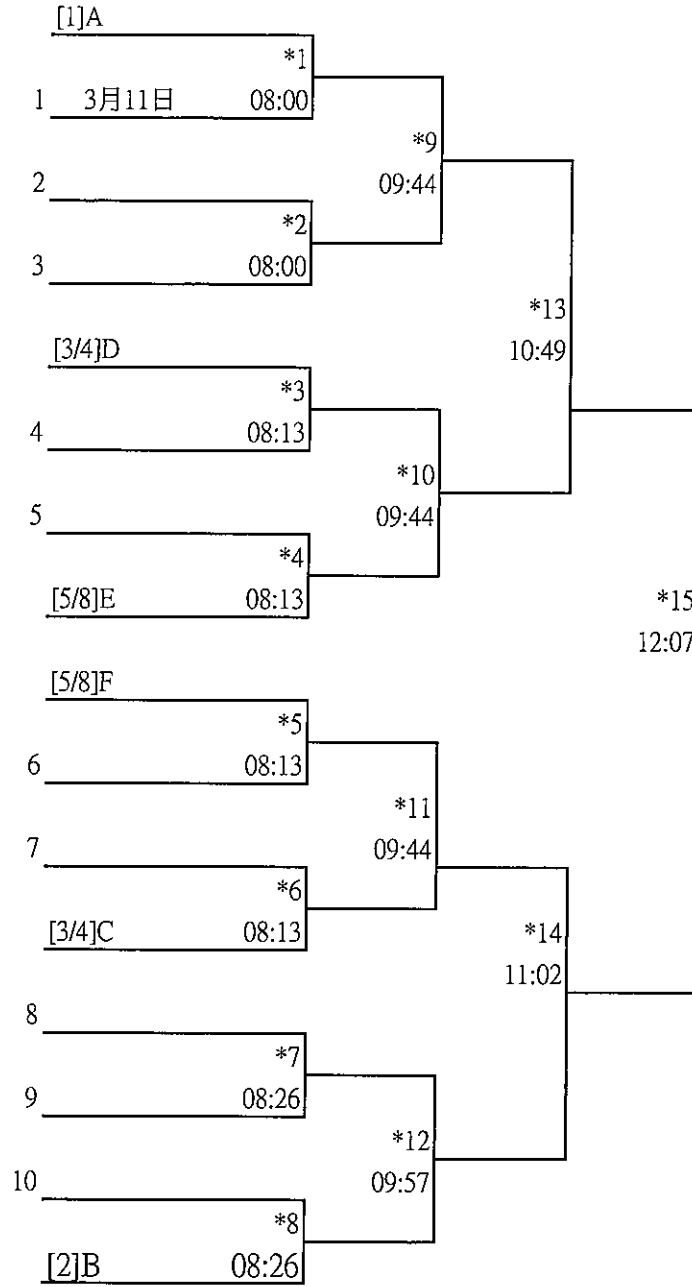

組別: 六男雙 15組,取8名

賽制:雙敗淘汰制

勝部:

3月10日

3月11日

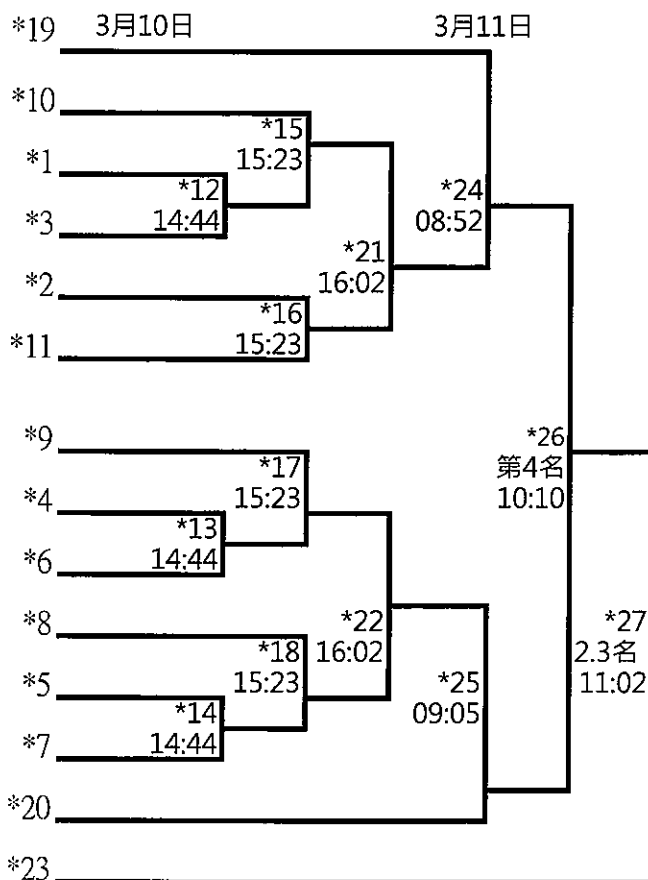
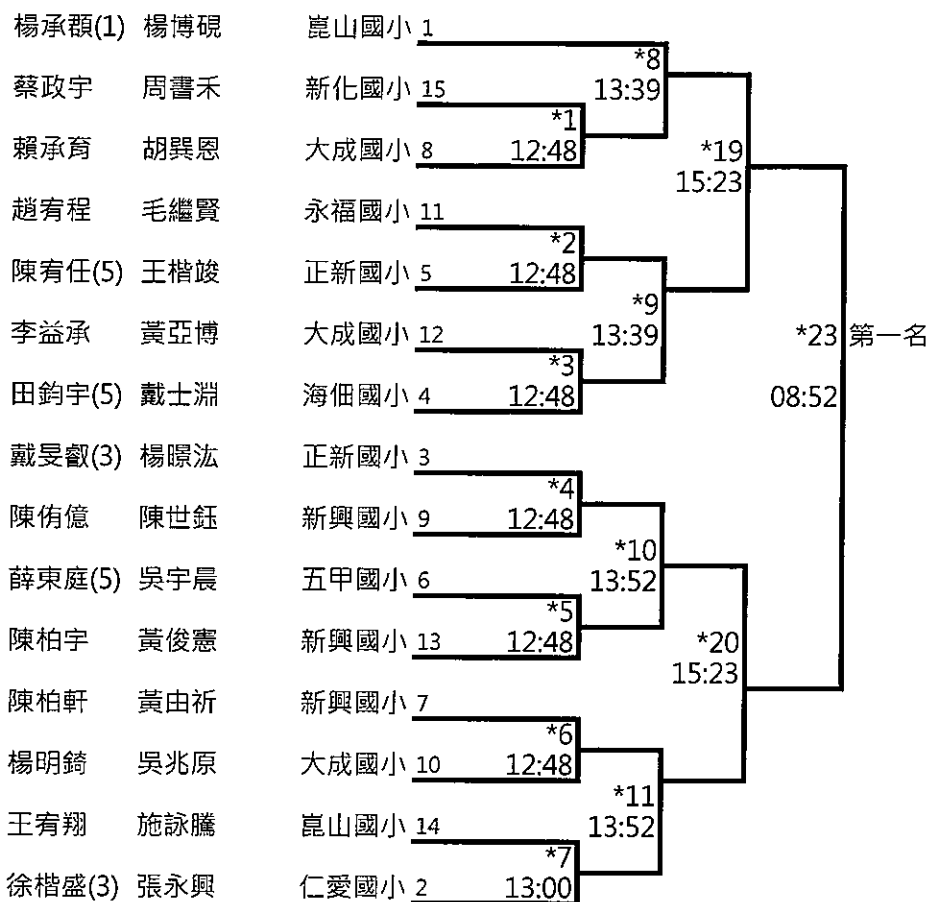

組別: 國小男團

11組,取8名

賽制:雙敗淘汰制

3月10日

勝部:

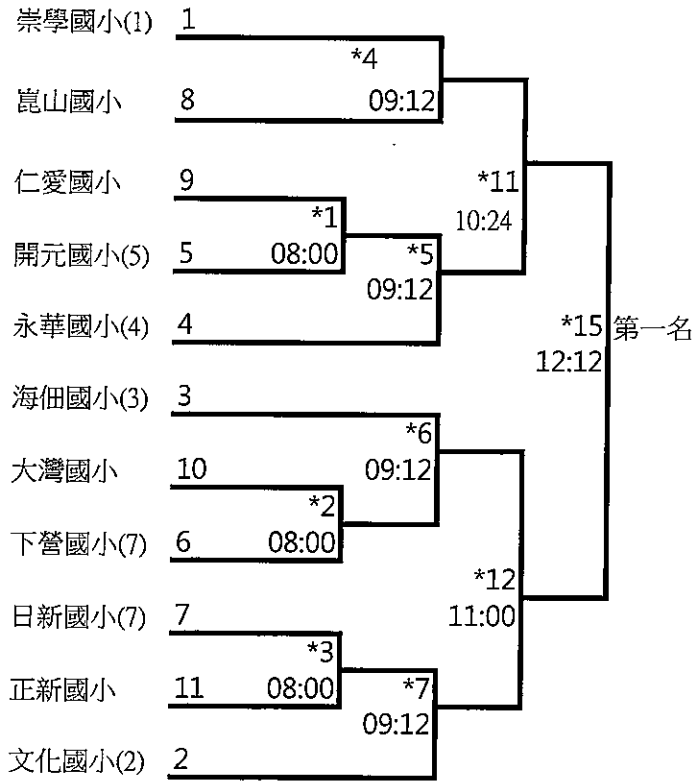

敗部:

