

組別: 高女單 14組,取8名

賽制:雙敗淘汰制

勝部:

9月23日

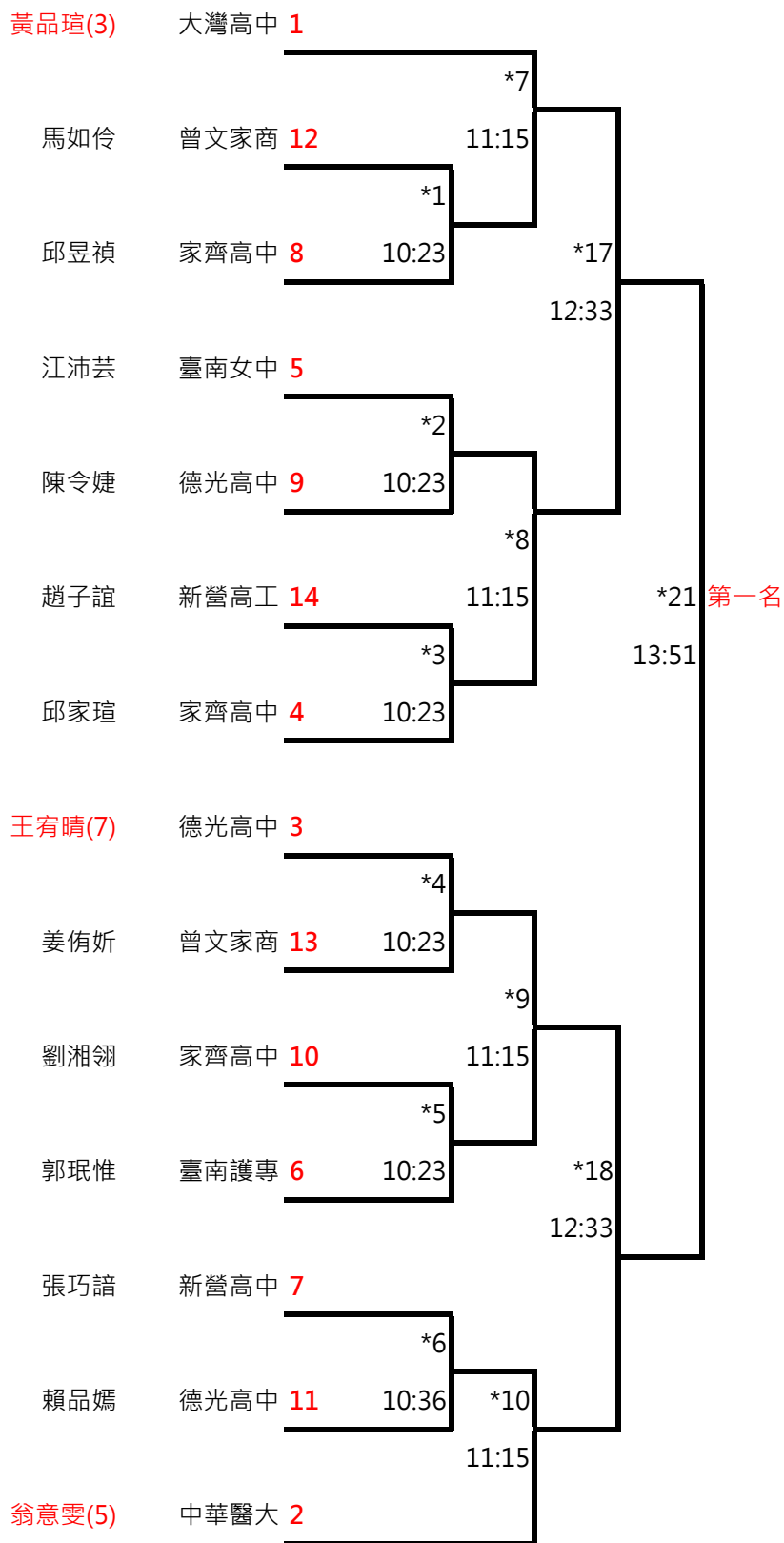

組別: 高女單 14組,取8名

賽制:雙敗淘汰制

敗部:

9月23日

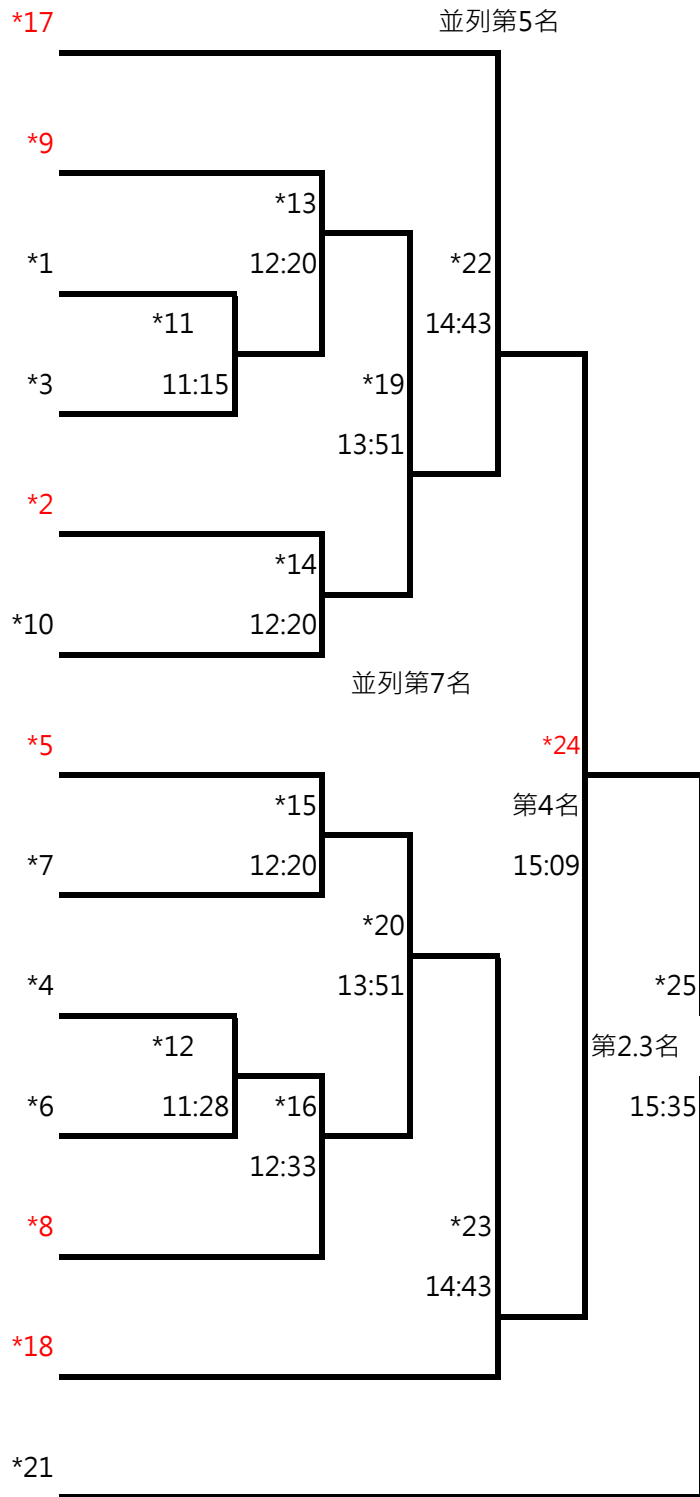

組別: 高女雙 12組,取8名 賽制:雙敗淘汰制  
 勝部: 9月23日

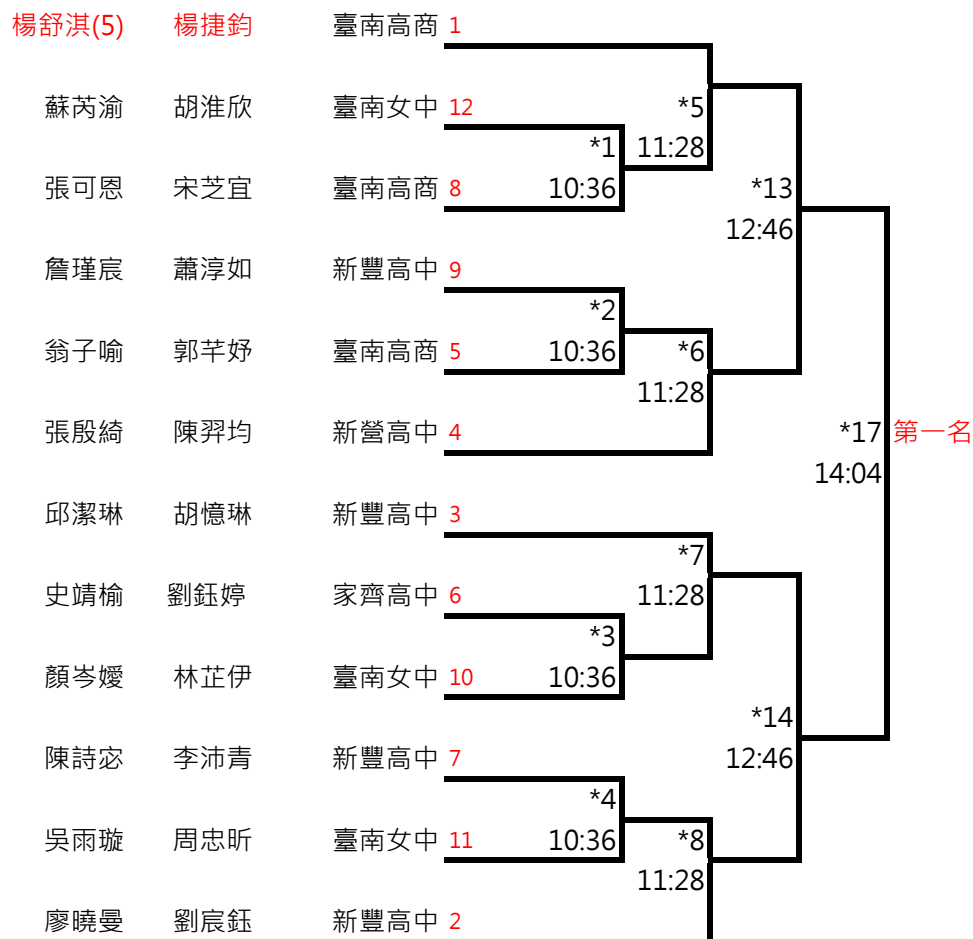

敗部:

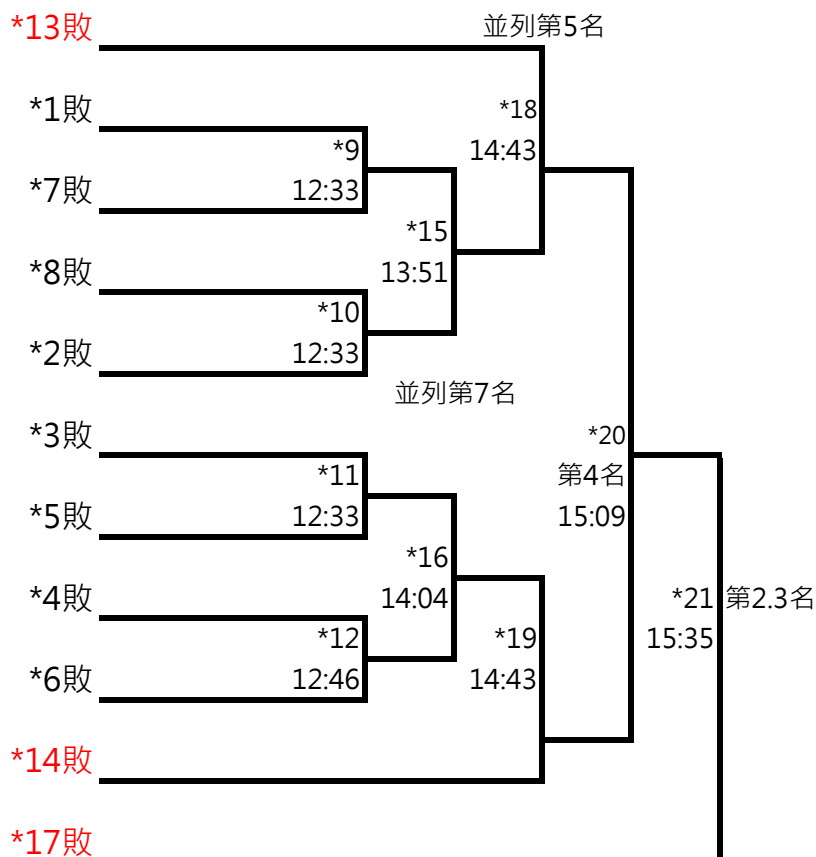

組別 高男單 預賽  
 組數 43 小組3取1、4取2  
 晉級 15

9月23日

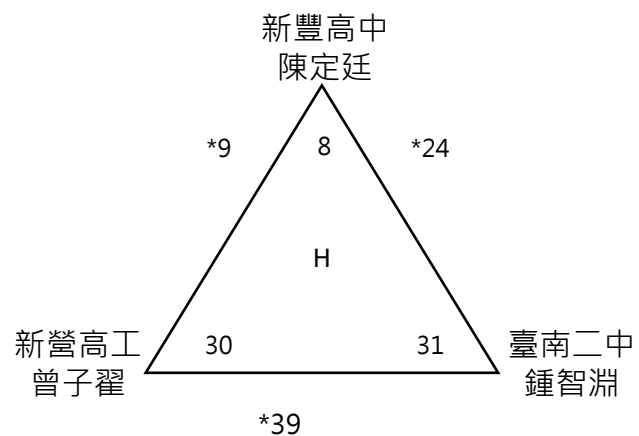
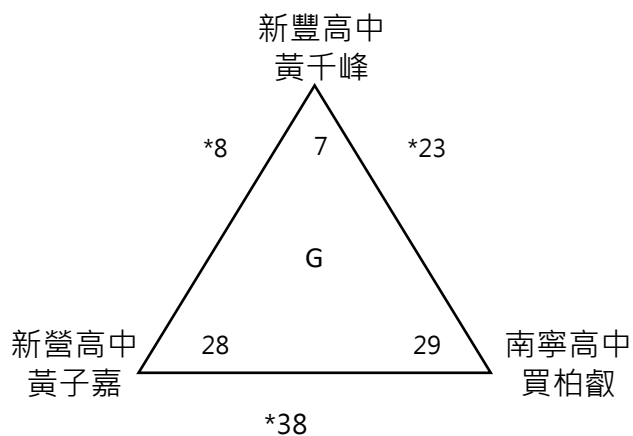
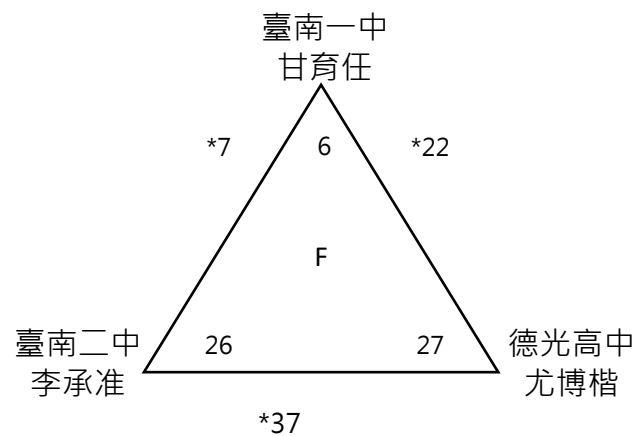
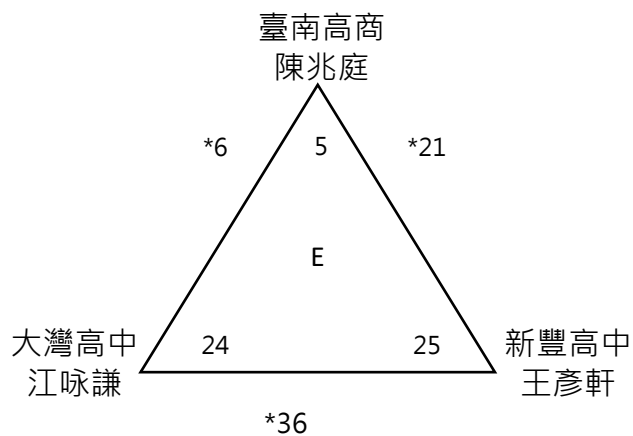
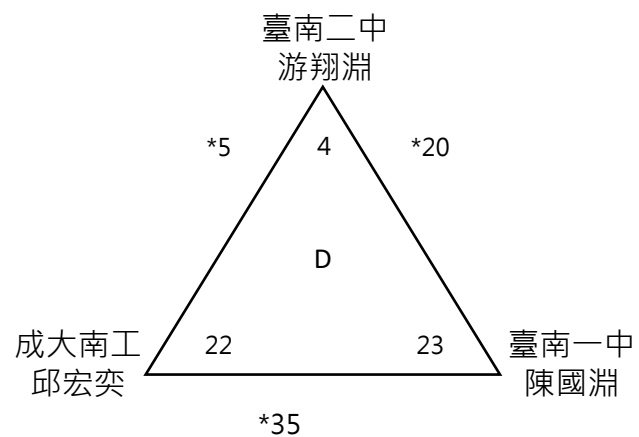
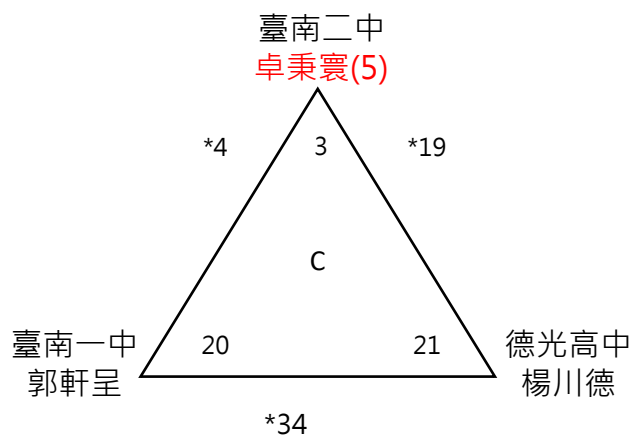
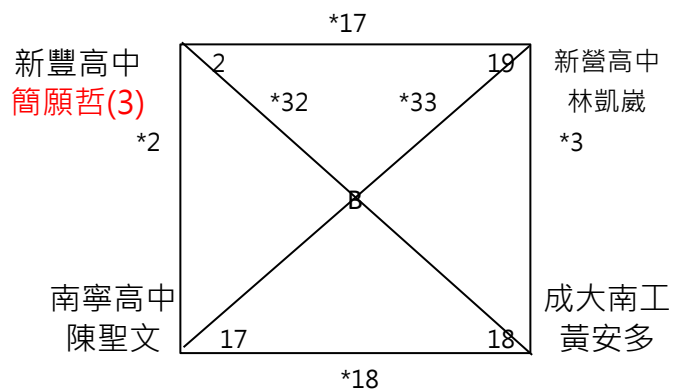
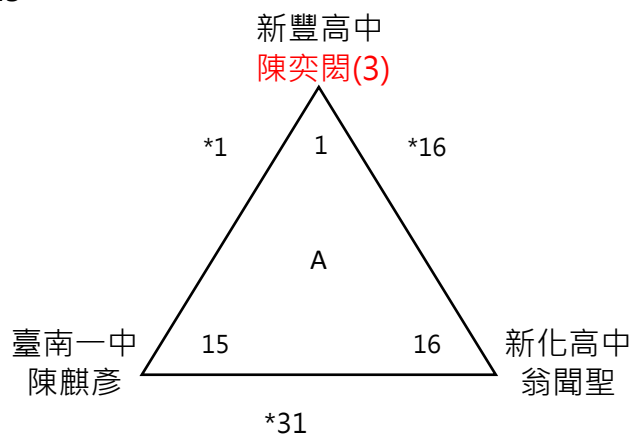

組別 高男單 預賽  
組數 43 小組3取1、4取2  
晉級 15

9月23日

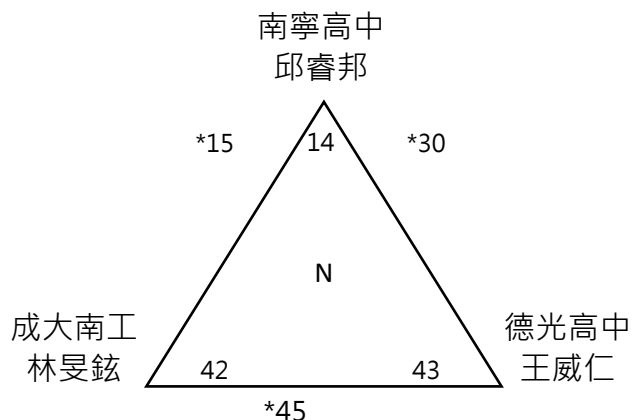
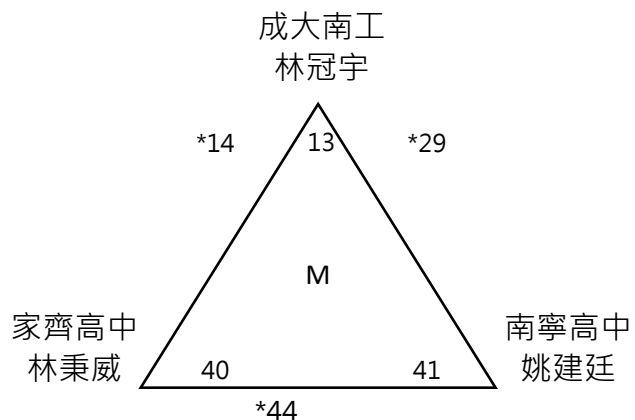
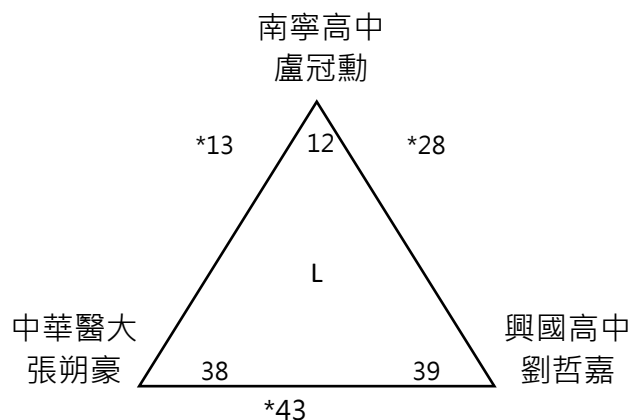
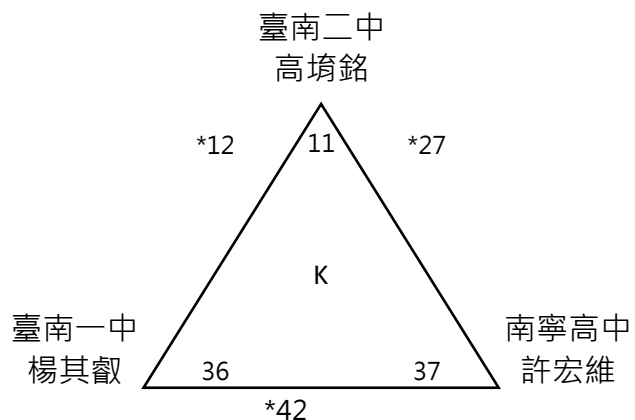
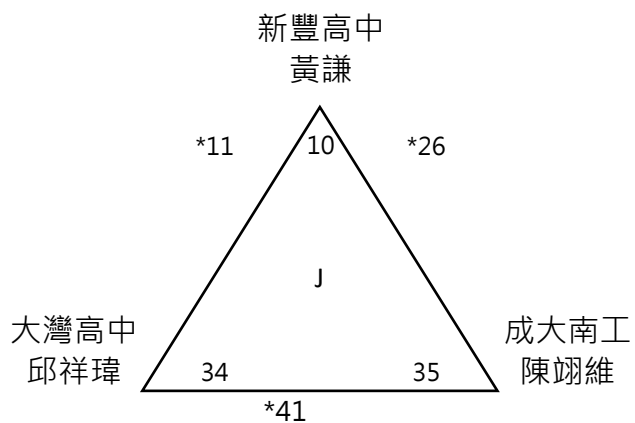
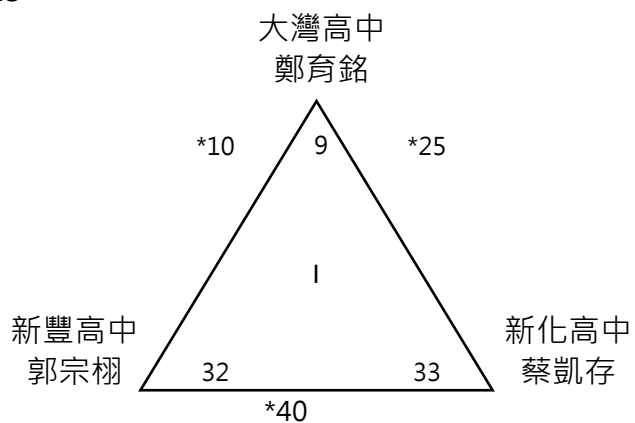

組別: 高男單決 9月23日

晉級: 15

籤號

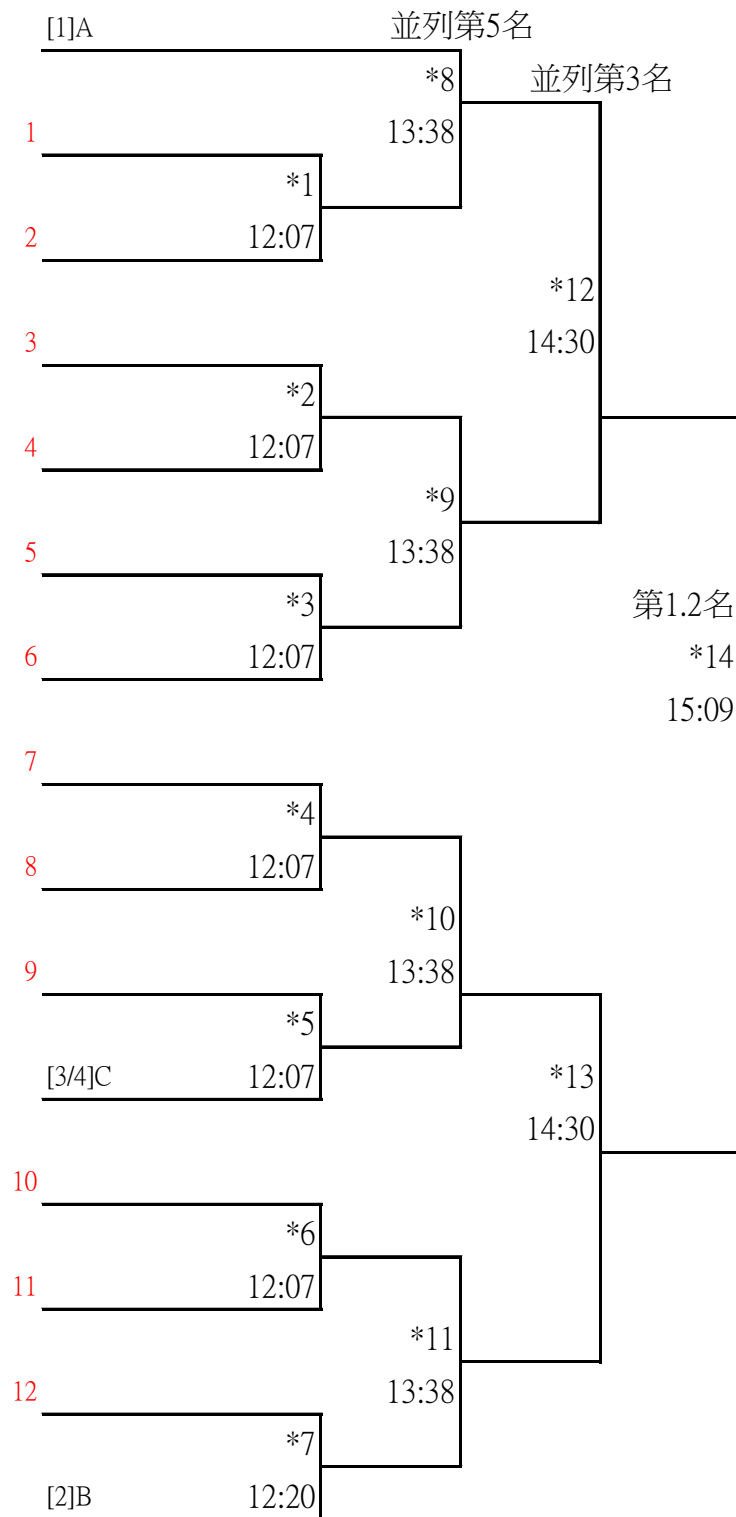

組別 高男雙 預賽  
 組數 26 小組3取1、4取2  
 晉級 10

9月23日

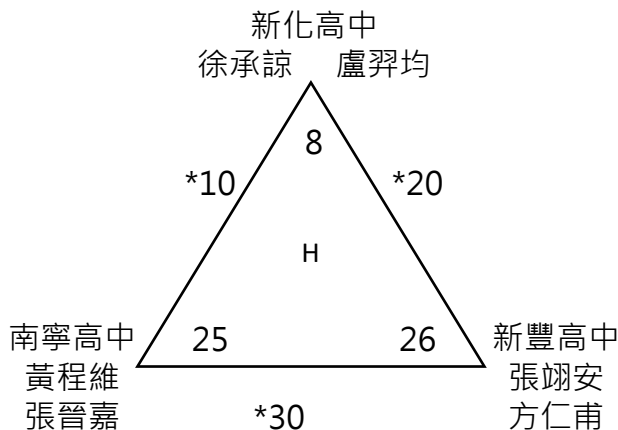
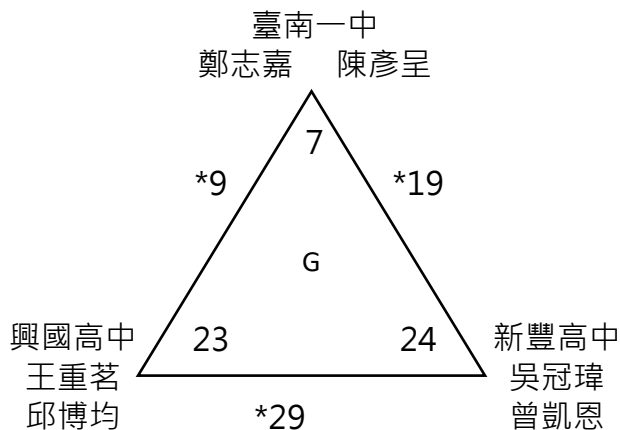
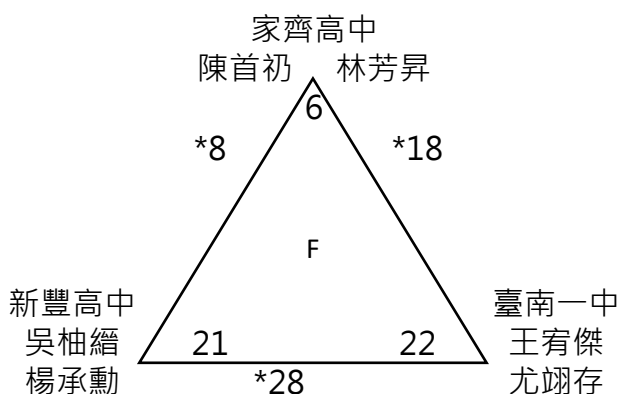
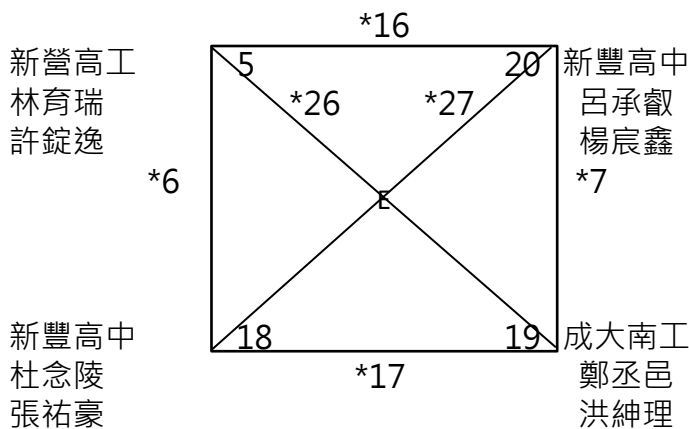
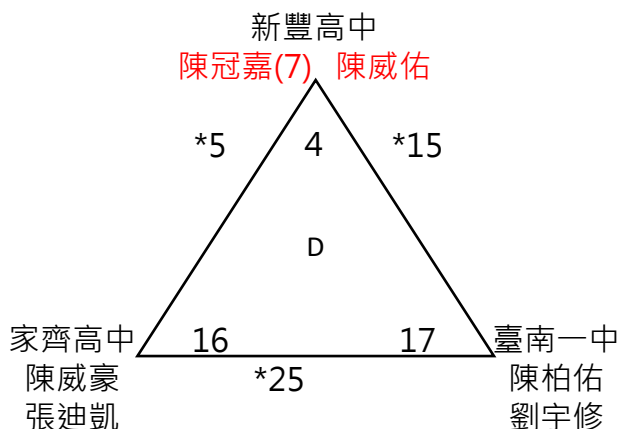
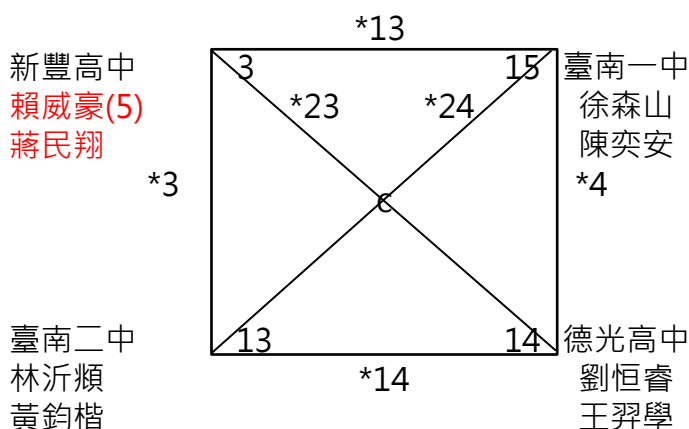
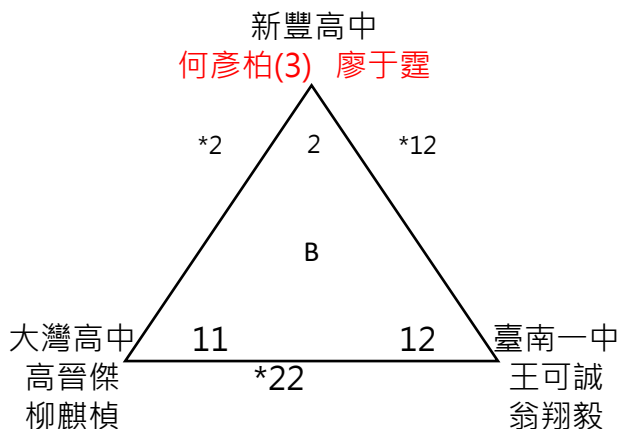
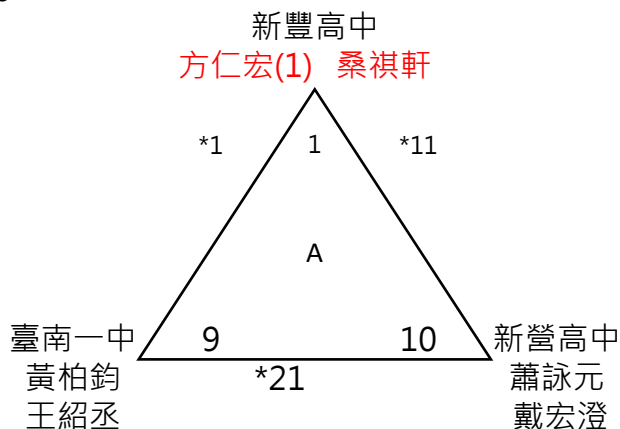

組別: 高男雙決  
晉級: 10

9月23日

籤號

