

組別 6女單 預賽
組數 24 小組3取1、4取2
晉級 8

9月24日

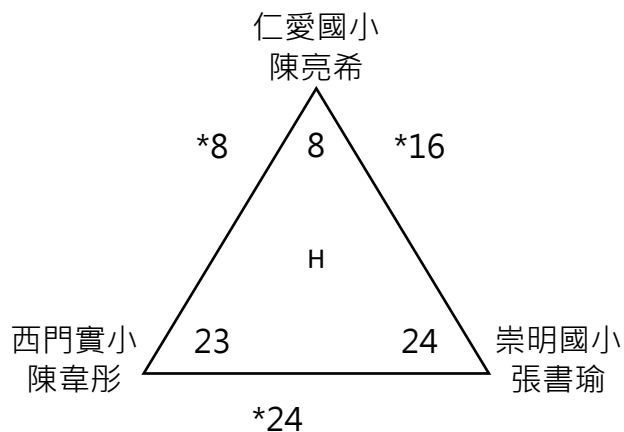
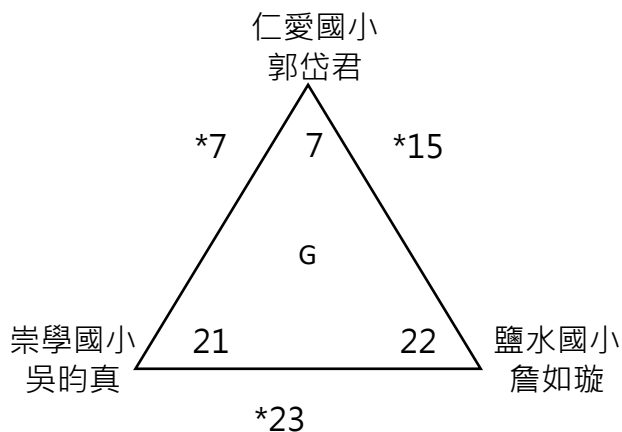
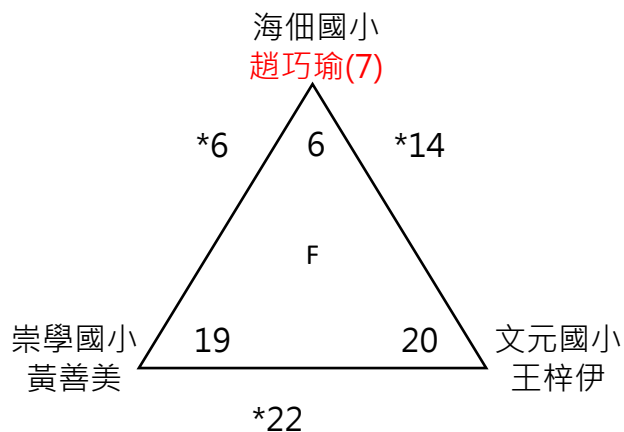
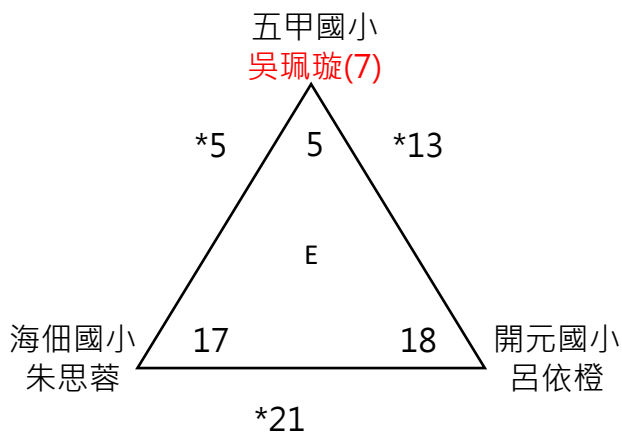
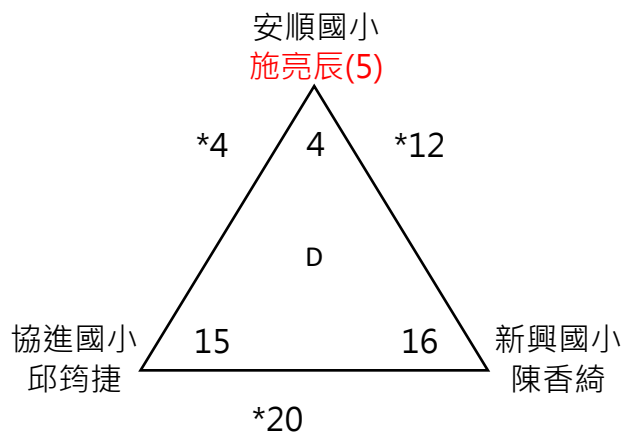
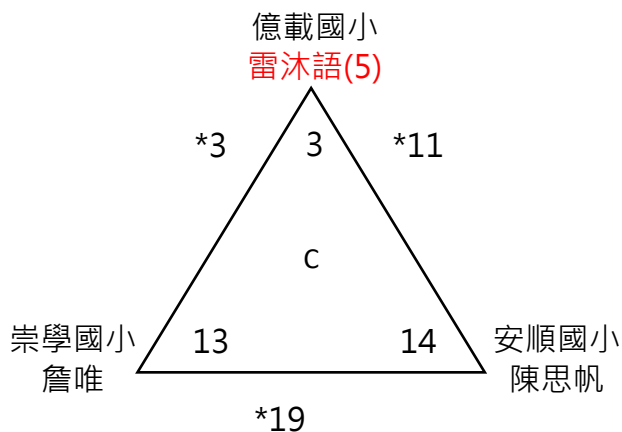
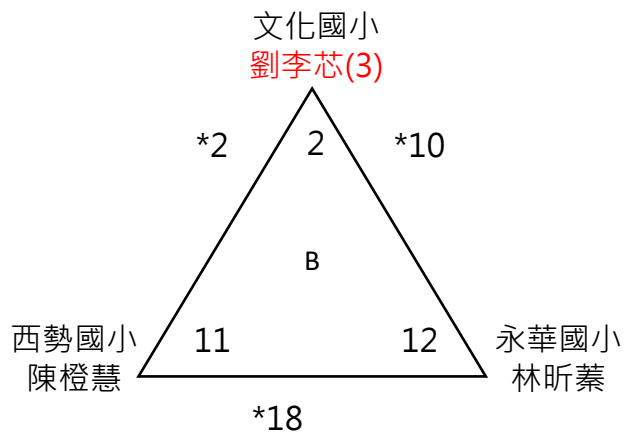
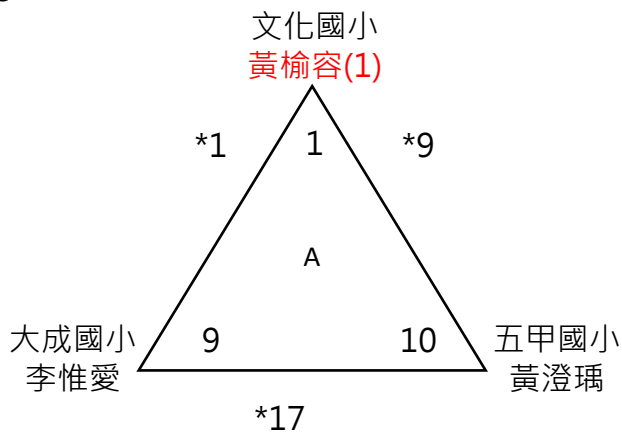

組別: 6女單決

9月24日

晉級: 8

籤號

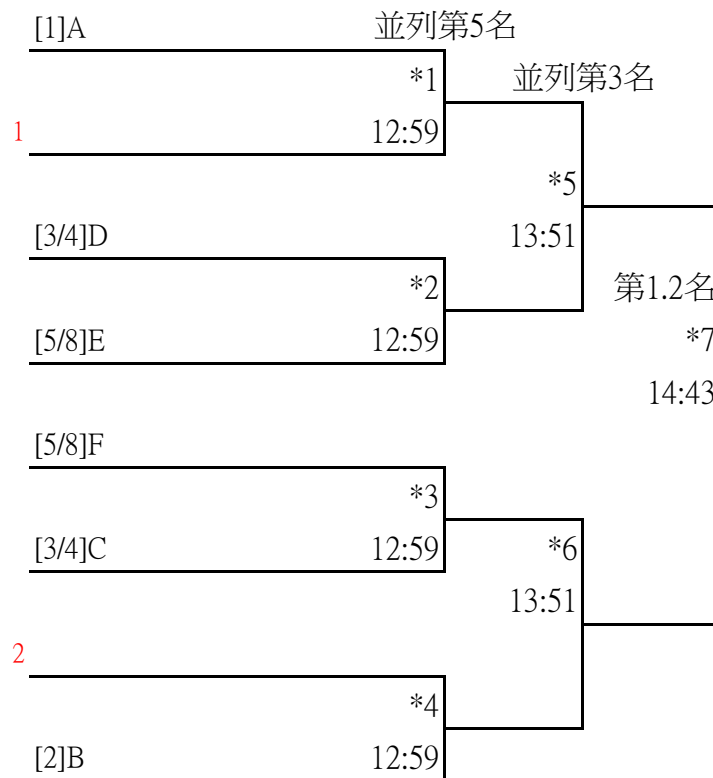

組別 5女單 預賽
組數 27 小組3取1、4取2
晉級 9

9月24日

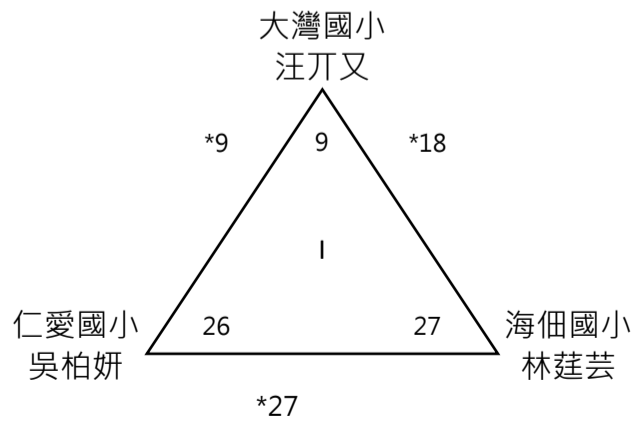
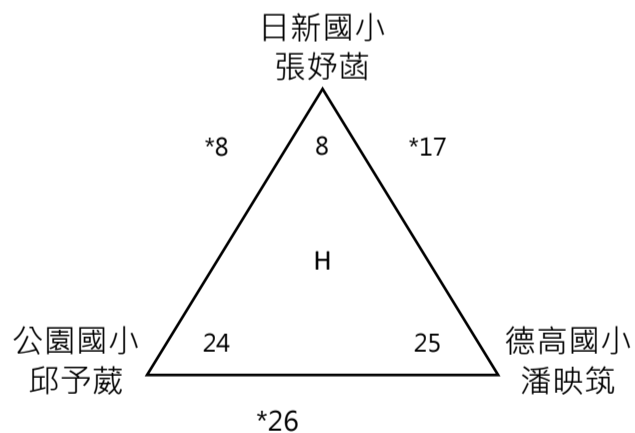
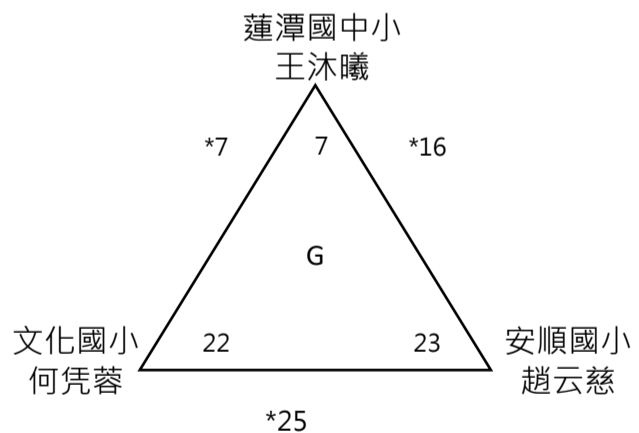
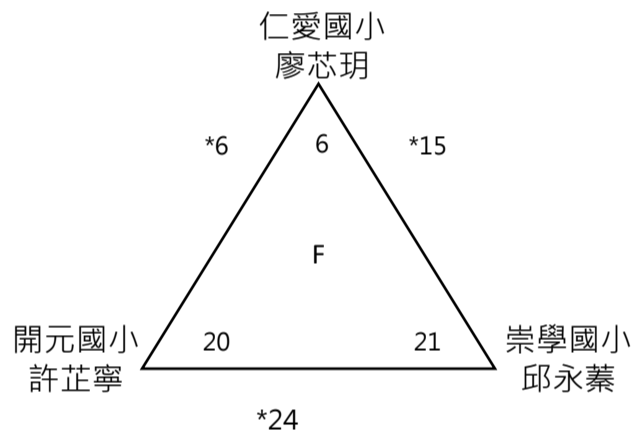
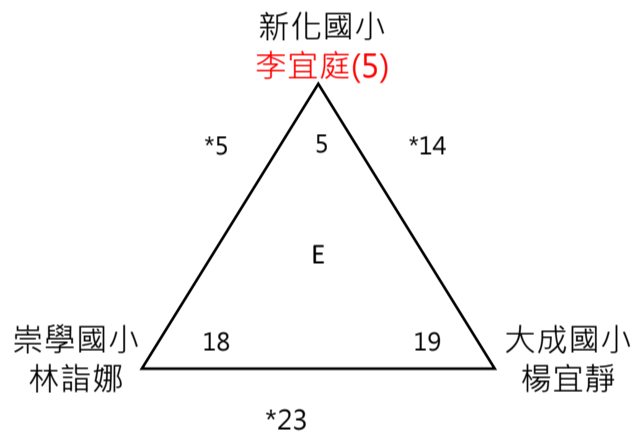
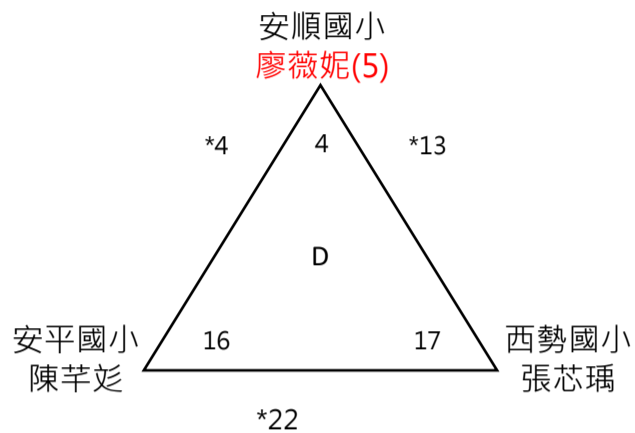
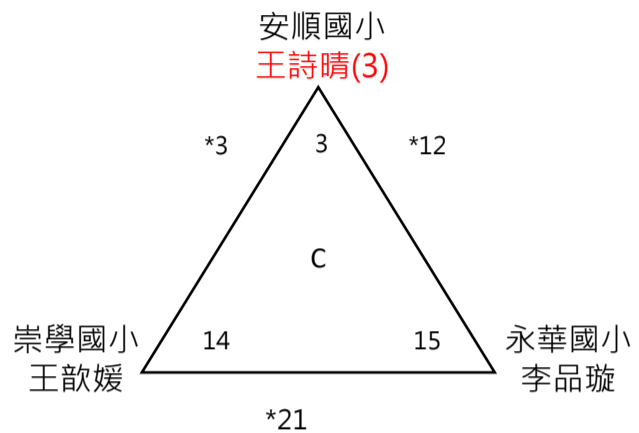
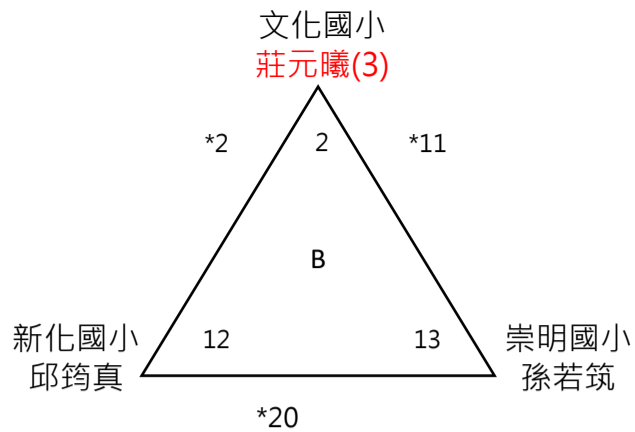
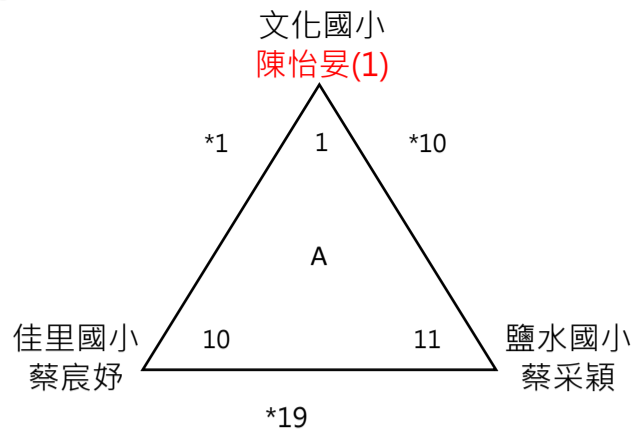

組別: 5女單決

9月25日

晉級: 9

籤號

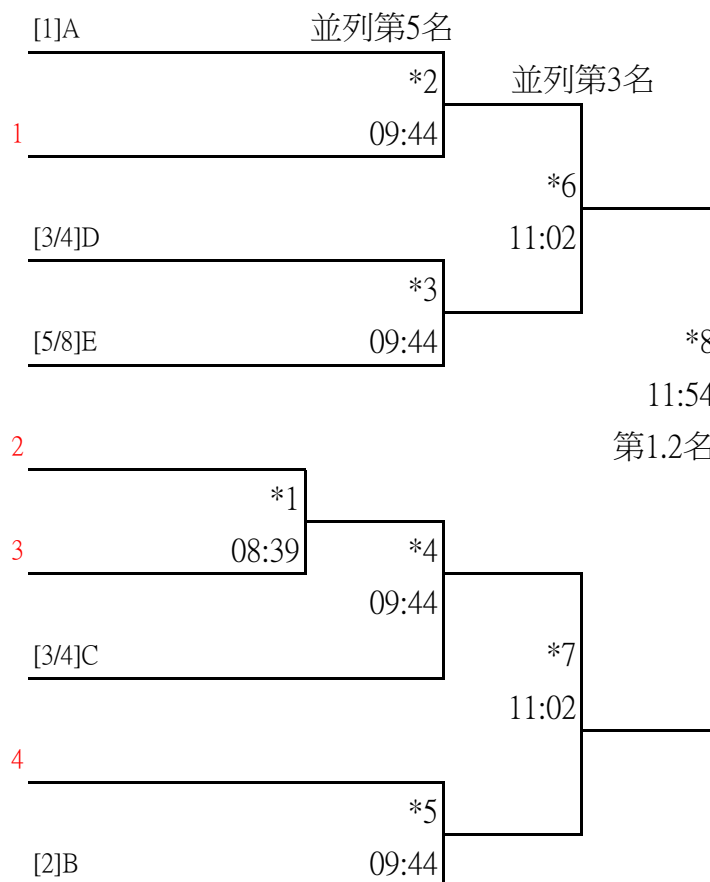

組別 4女單 預賽
組數 36 小組3取1、4取2
晉級 12

9月25日

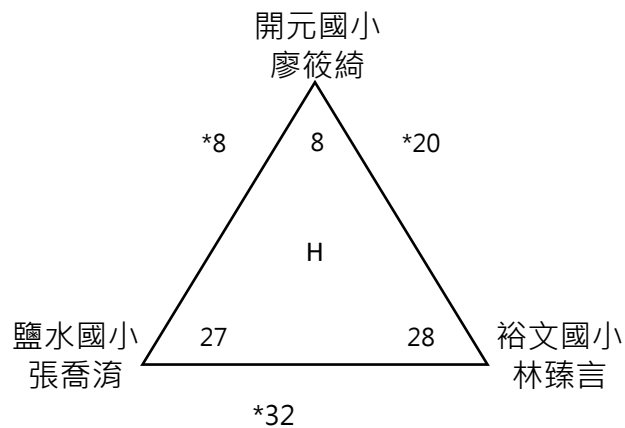
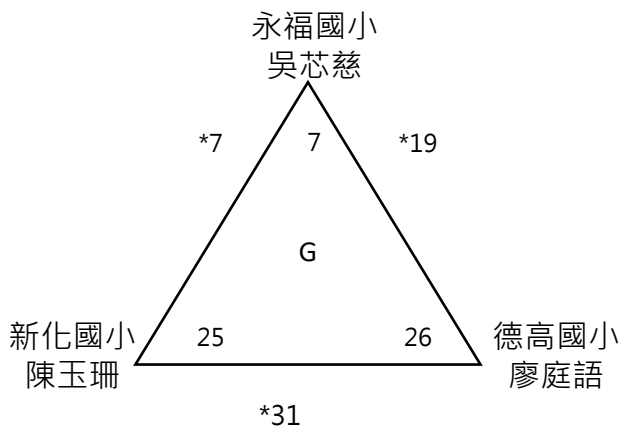
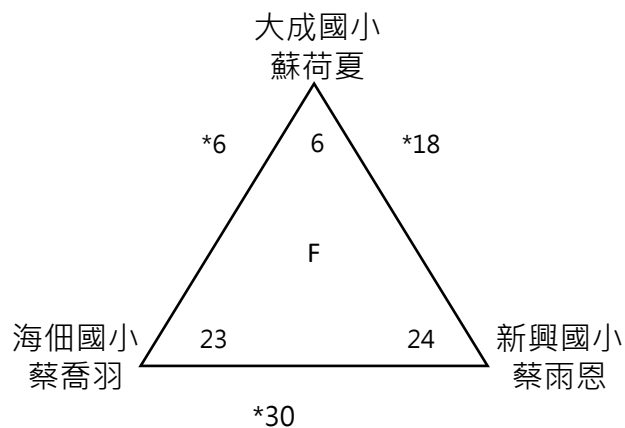
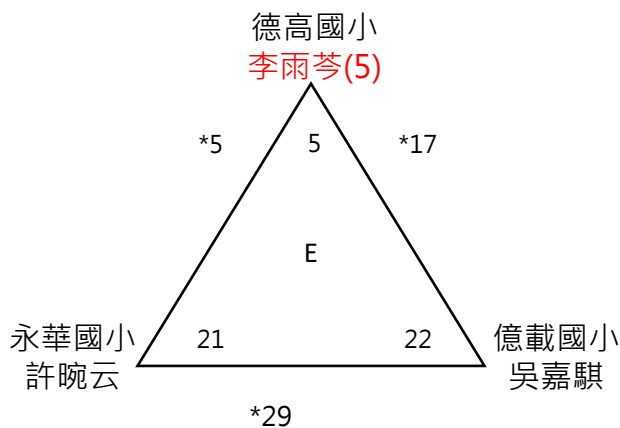
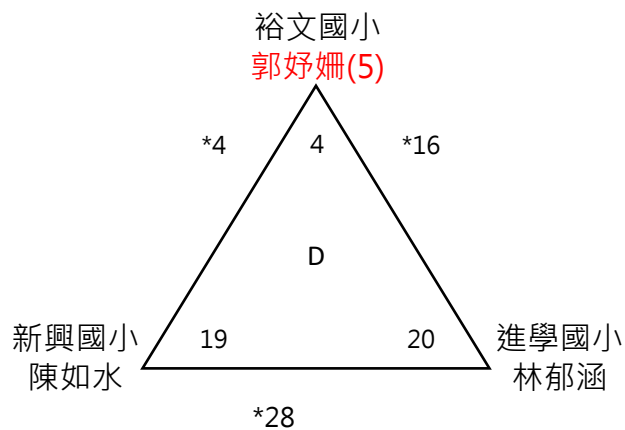
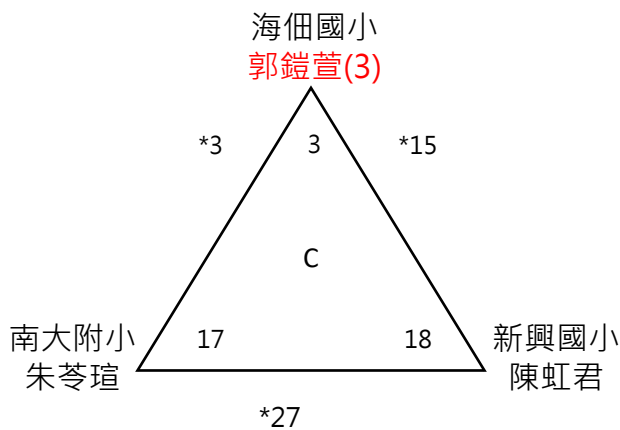
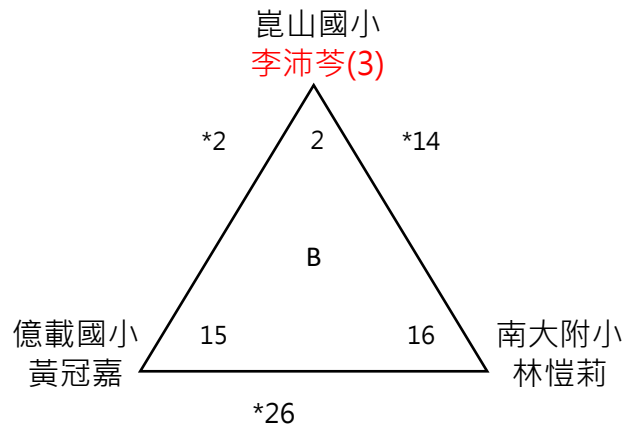
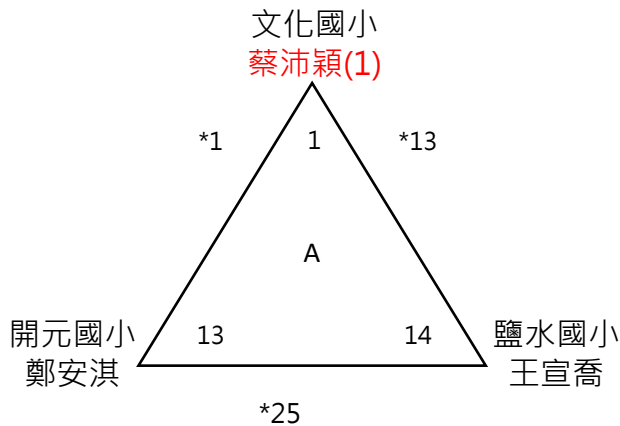

組別 4女單 預賽
組數 36 小組3取1、4取2
晉級 12

9月25日

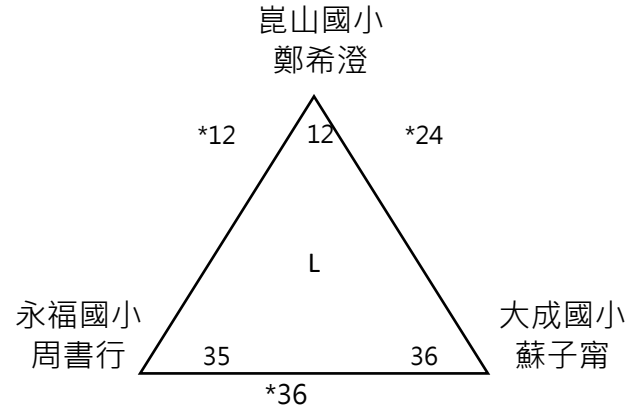
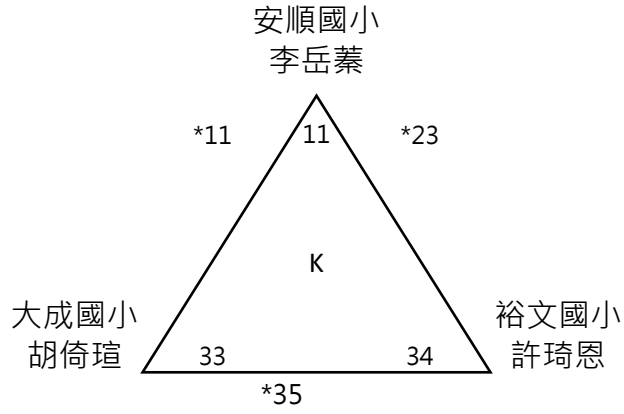
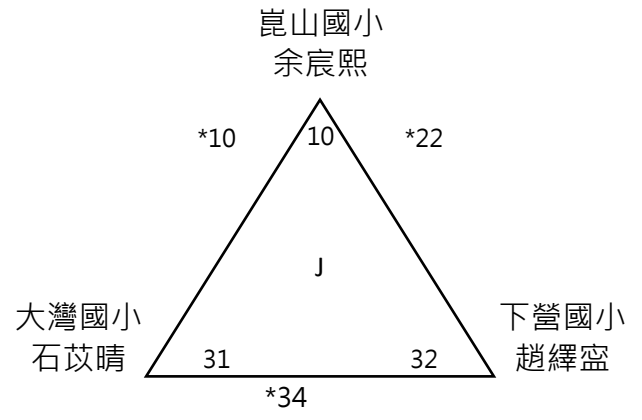
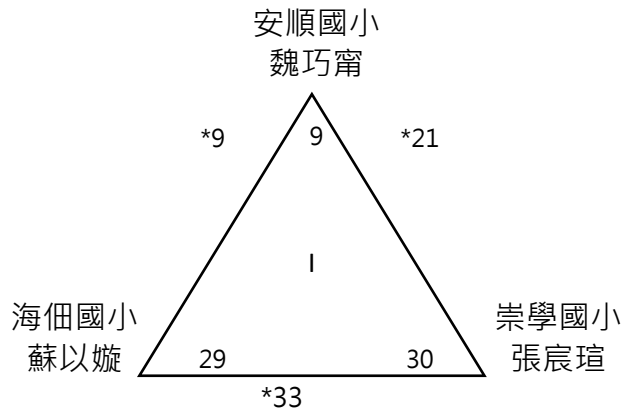

組別 3女單 預賽
 組數 41 小組3取1、4取2
 晉級 15

9月26日

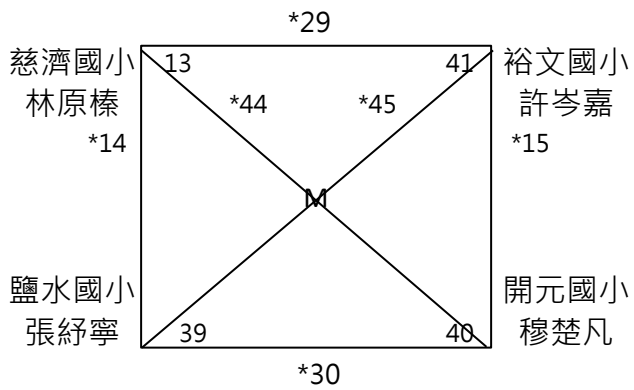
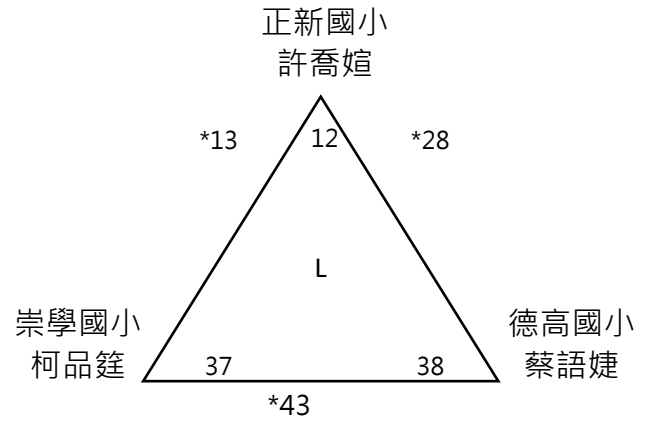
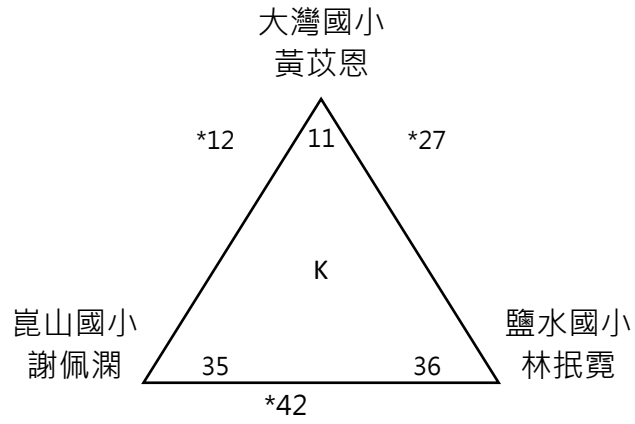
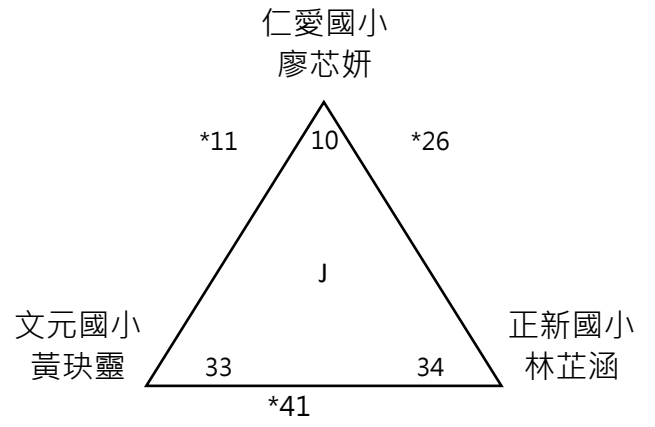
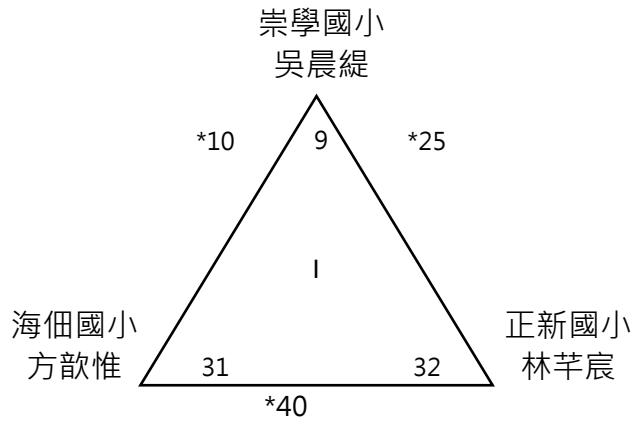

組別: 3女單決
晉級: 15

9月26日

籤號

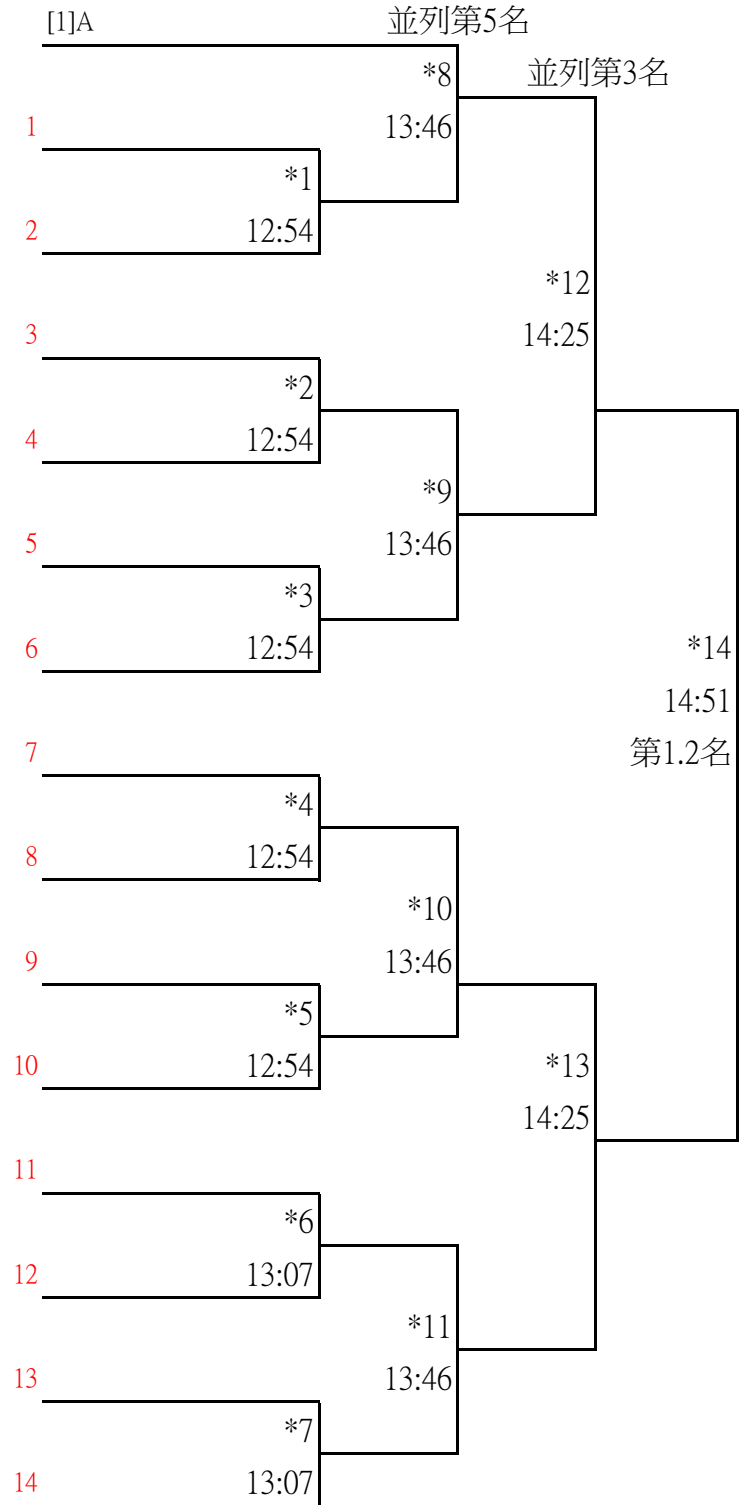

組別 6男單
組數 52 小組3取1、4取2
晉級 18

9月24日

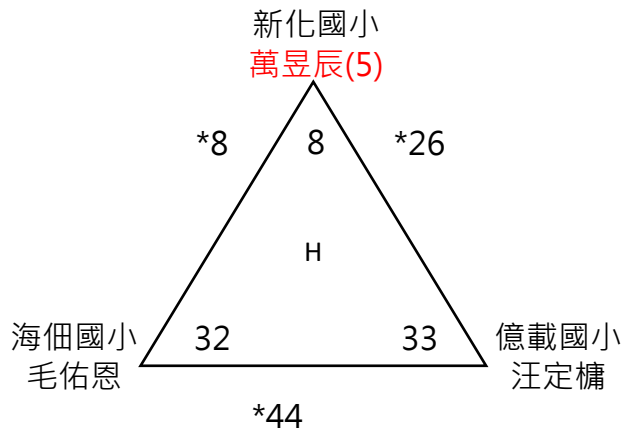
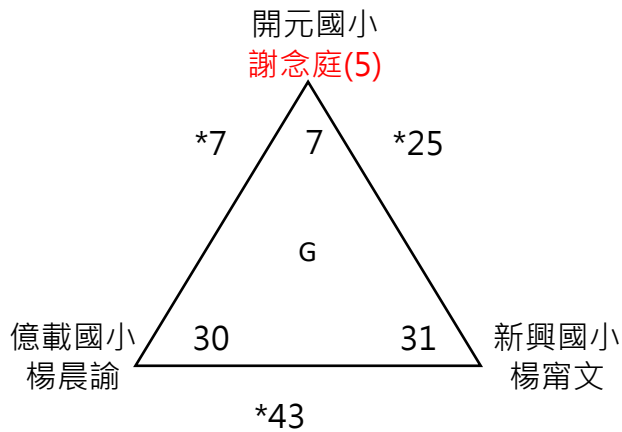
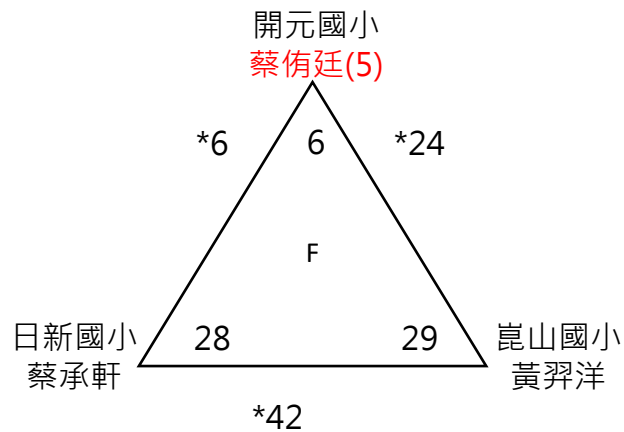
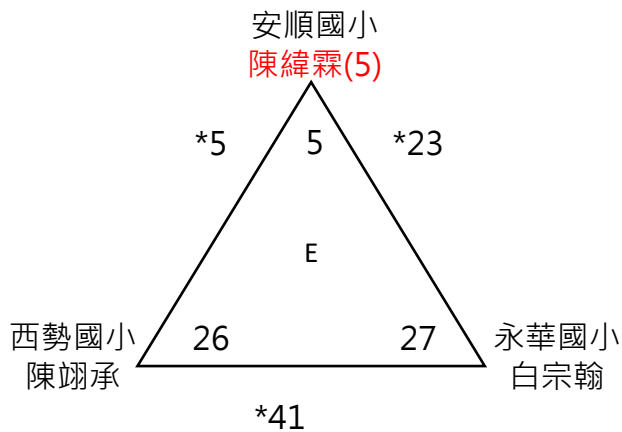
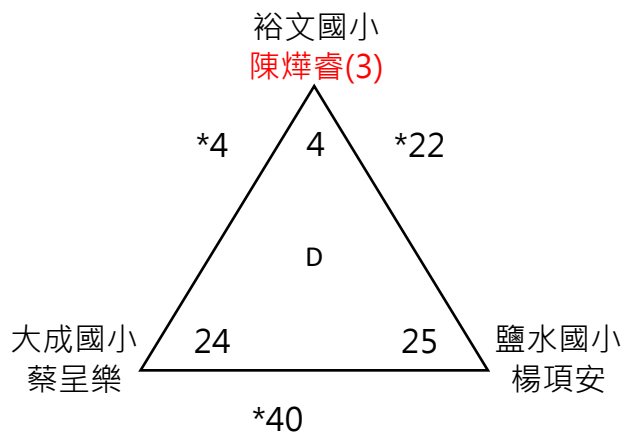
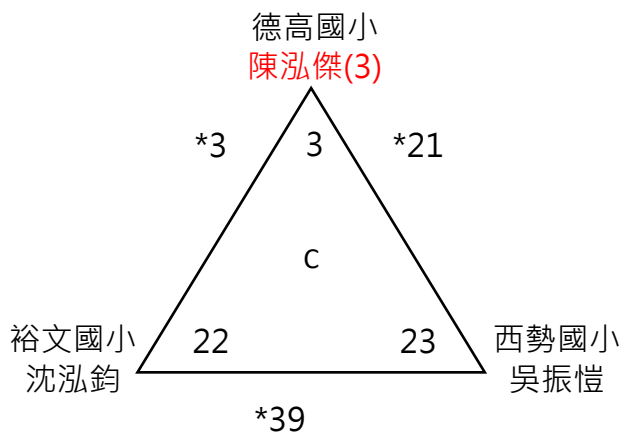
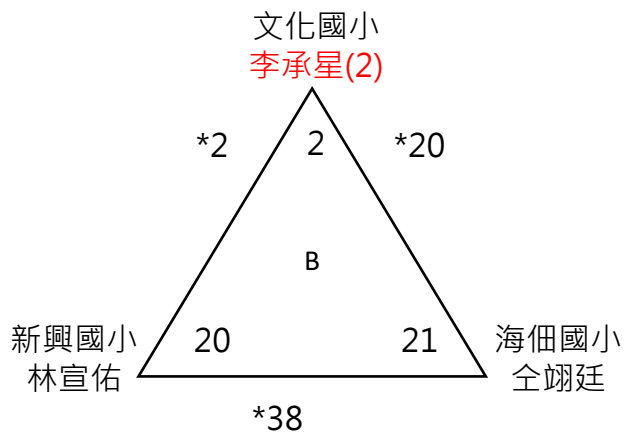
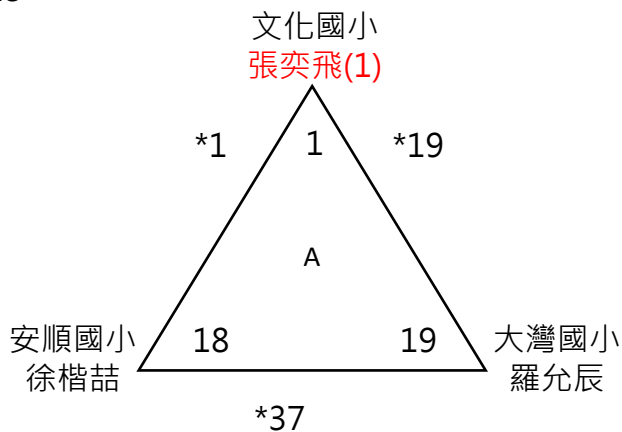

組別 6男單
 組數 52 小組3取1、4取2
 晉級 18

9月24日

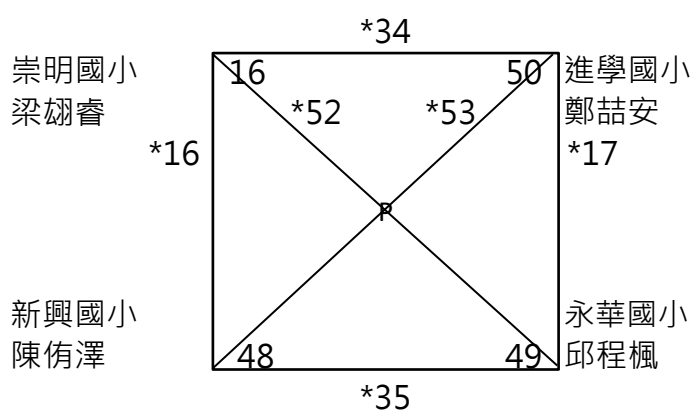
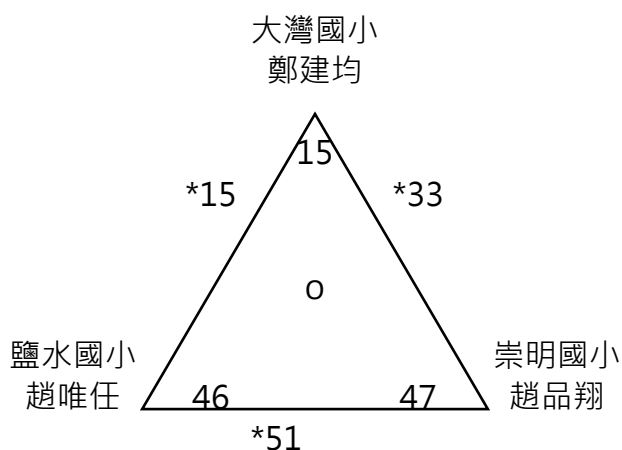
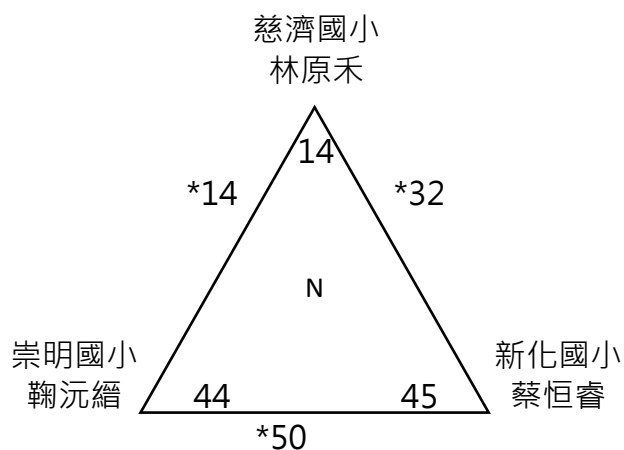
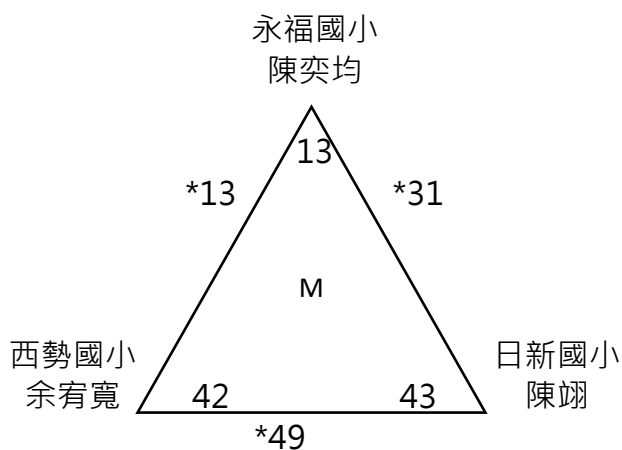
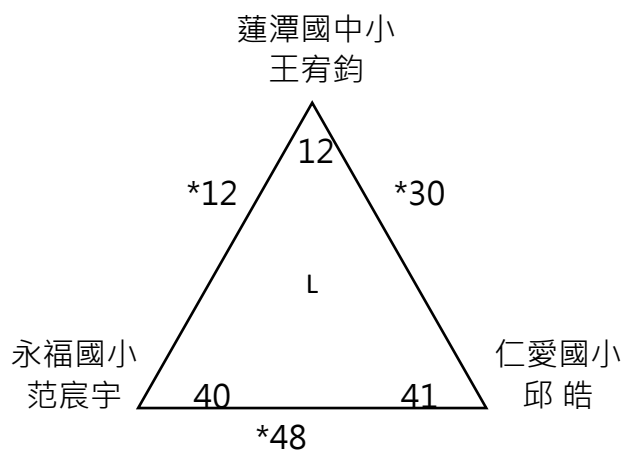
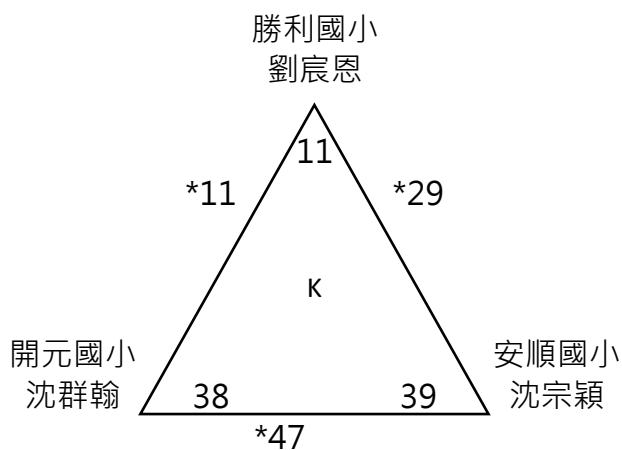
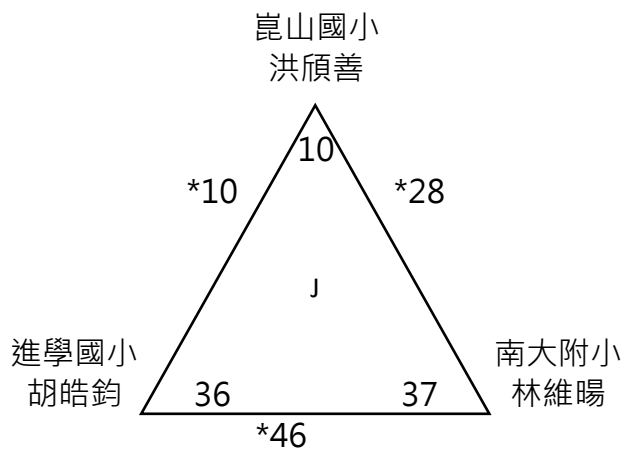
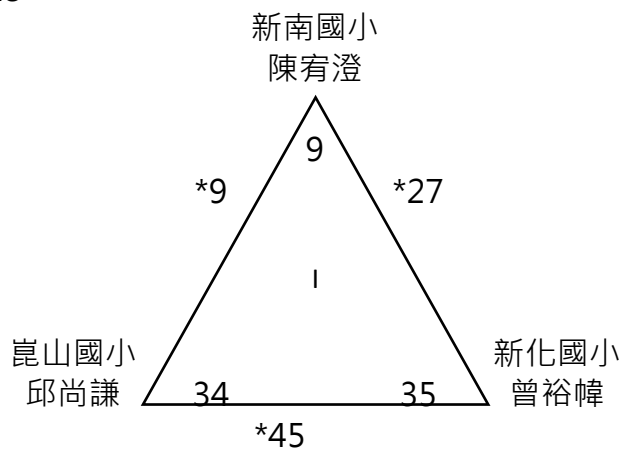

組別 6男單

組數 52 小組3取1、4取2

9月24日

晉級 18

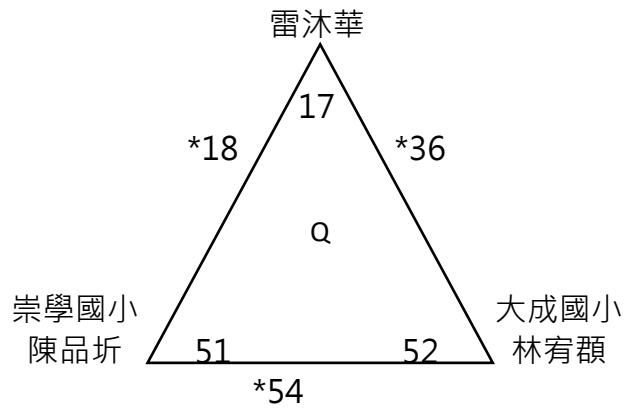

組別: 6男單決

9月25日

晉級: 18

籤號

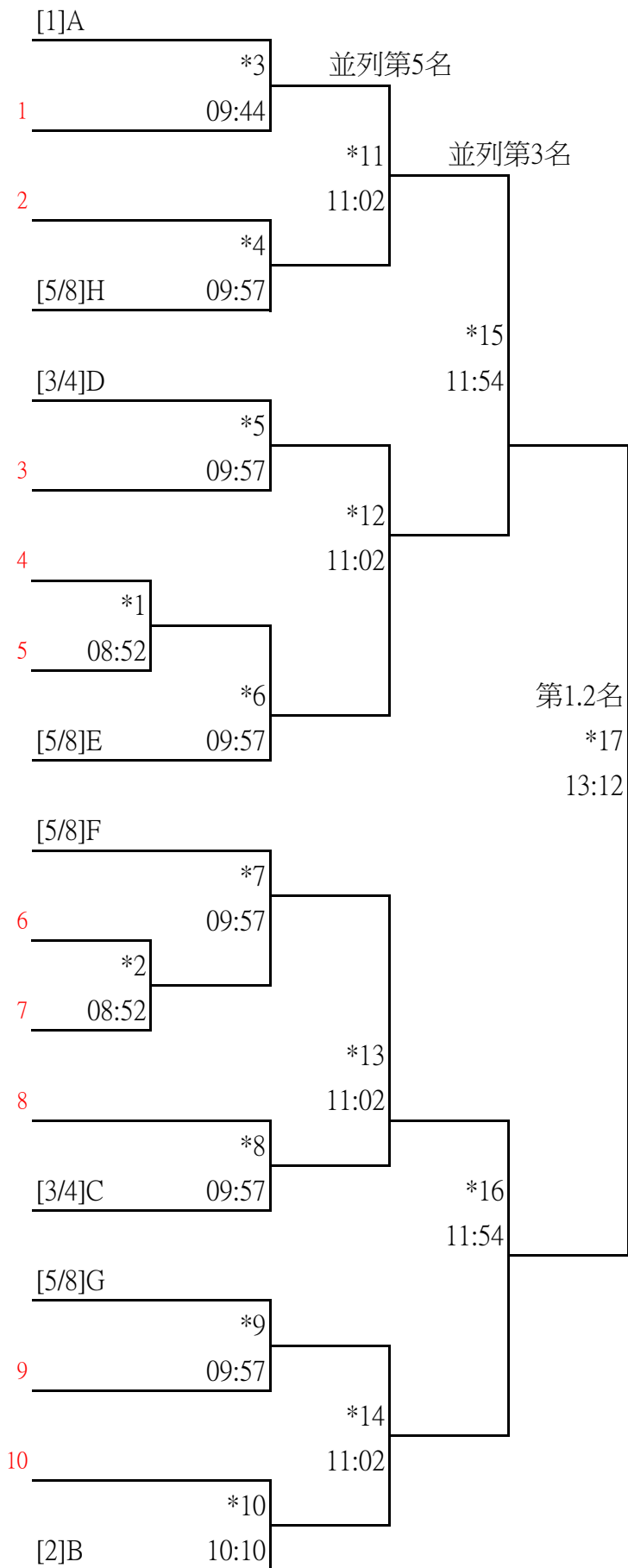

組別 5男單 預賽
組數 65 小組3取1、4取2
晉級 23

9月25日

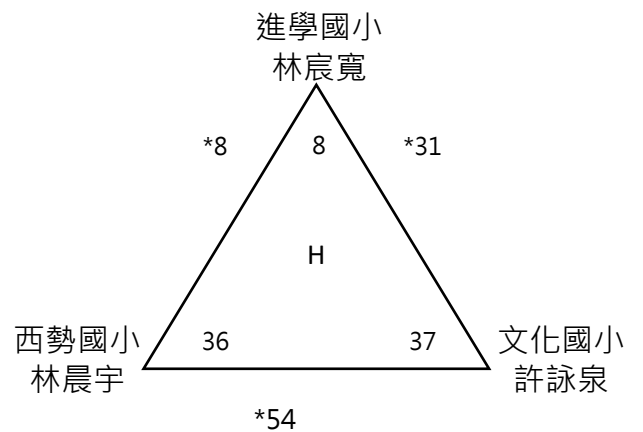
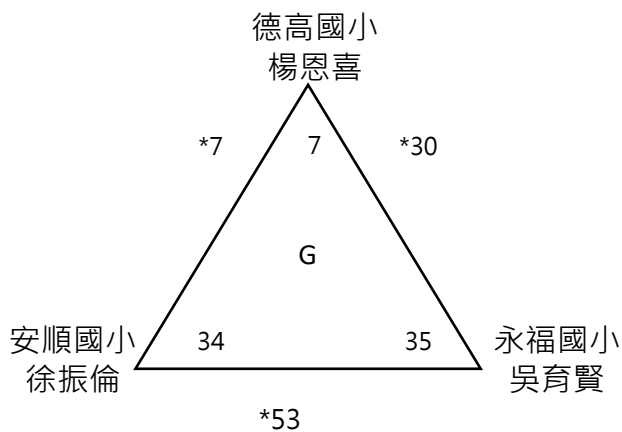
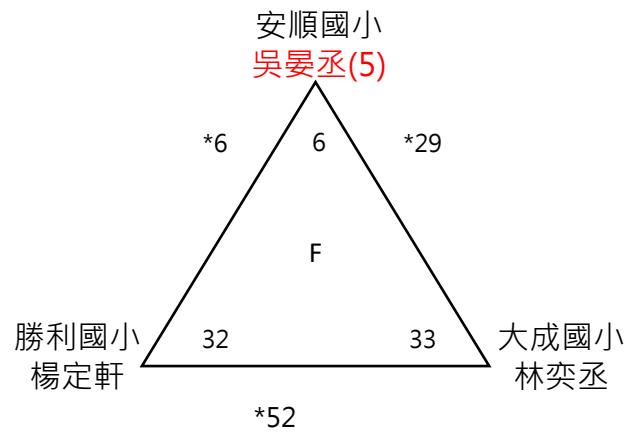
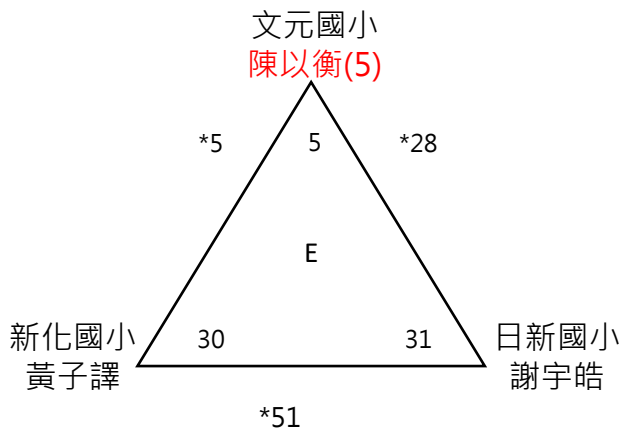
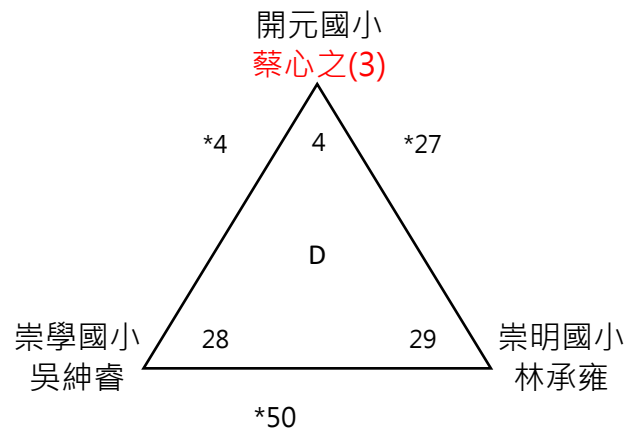
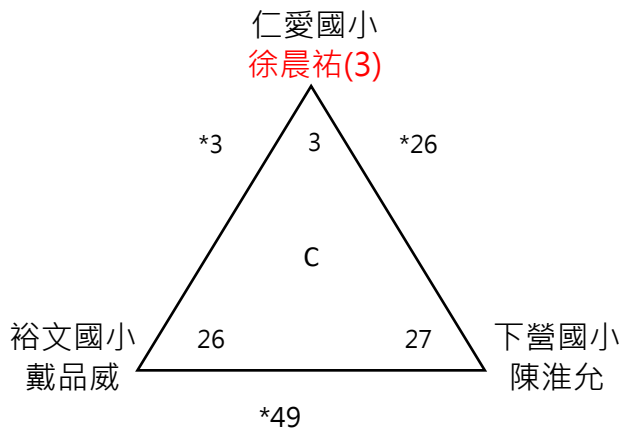
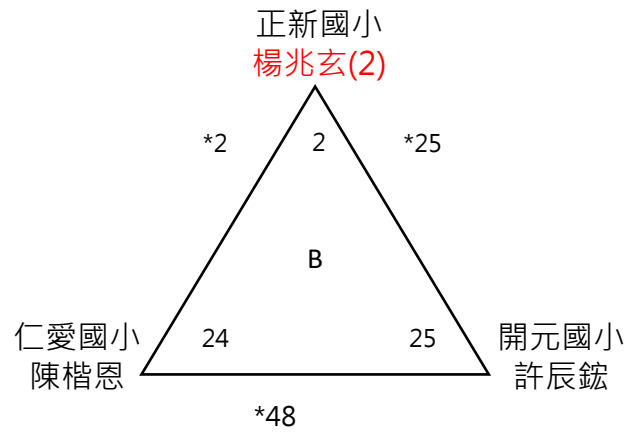
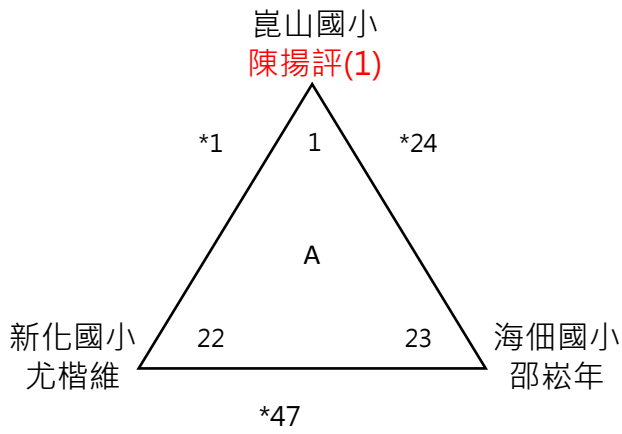

組別 5男單 預賽
 組數 65 小組3取1、4取2
 晉級 23

9月25日

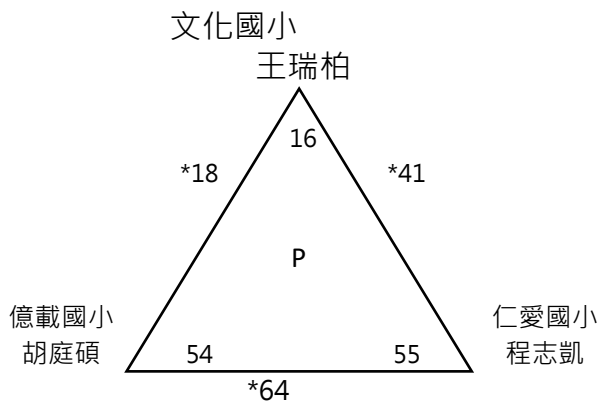
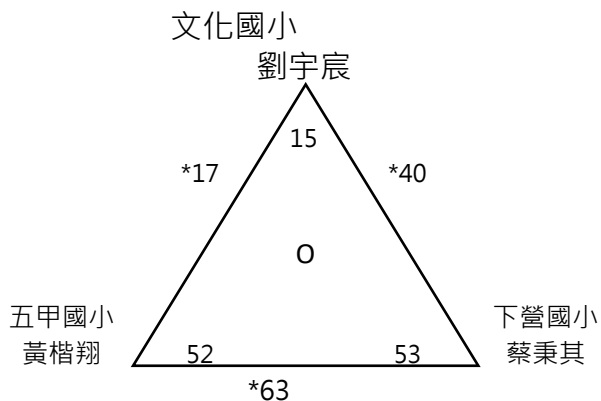
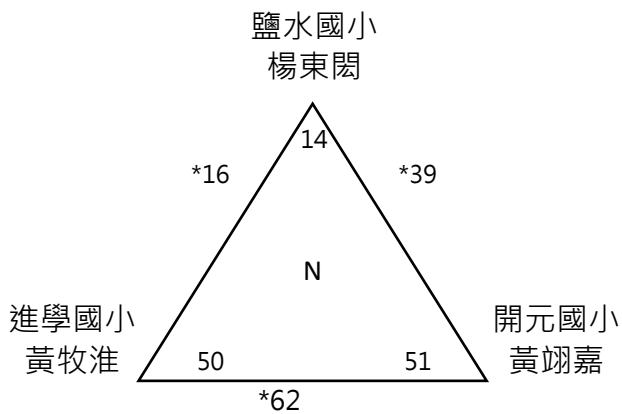
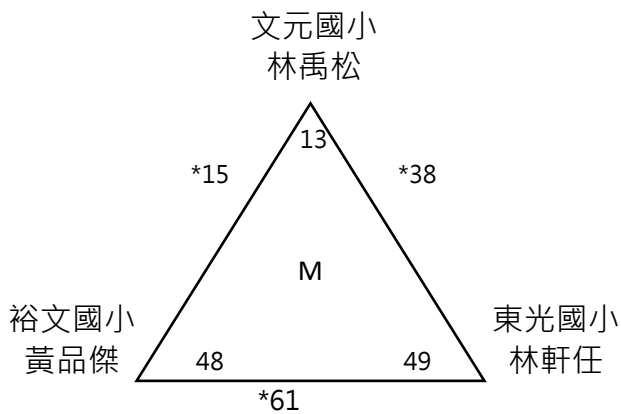
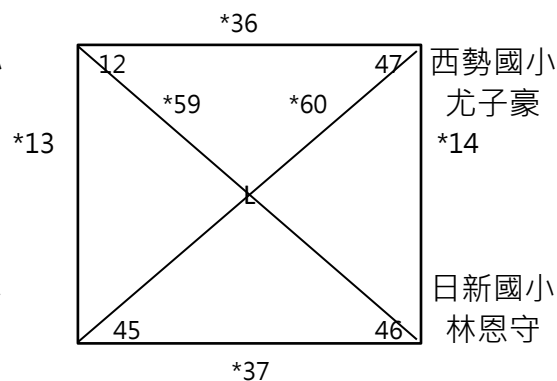
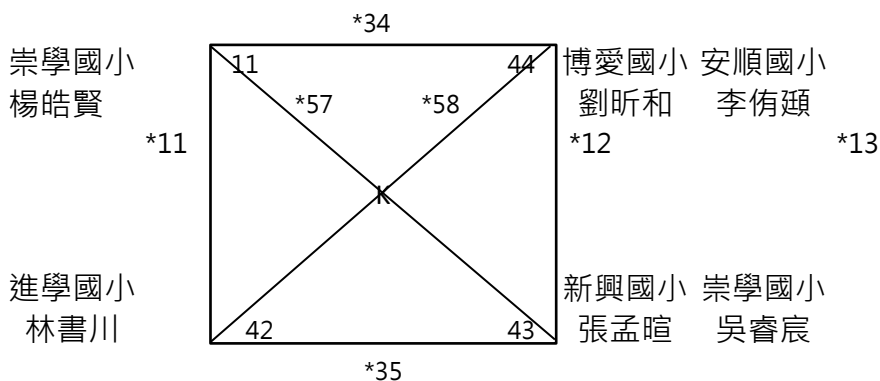
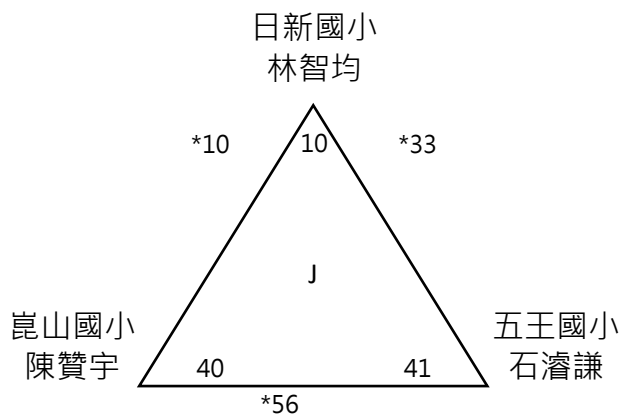
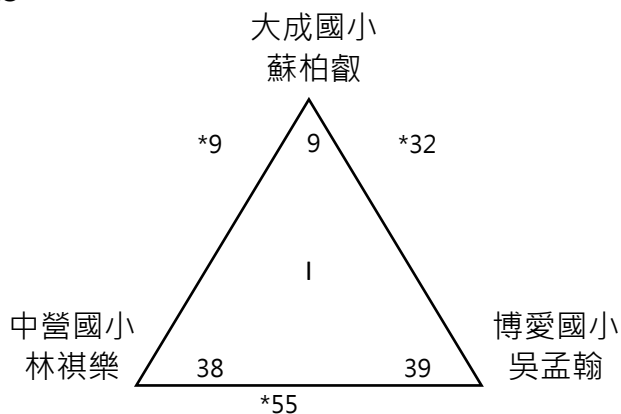

組別 5男單 預賽
組數 65 小組3取1、4取2
晉級 23

9月25日

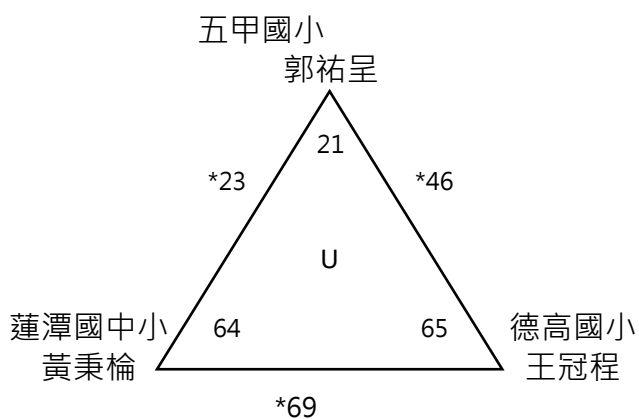
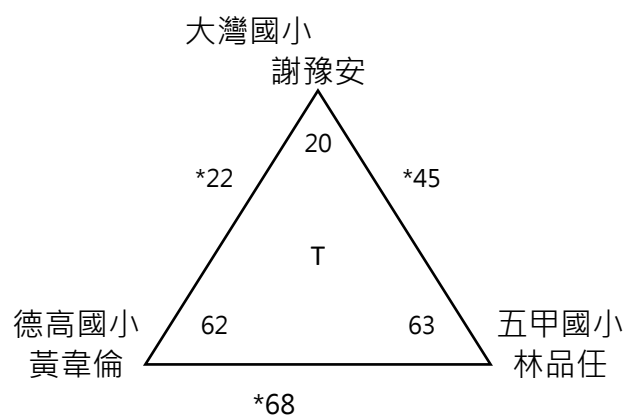
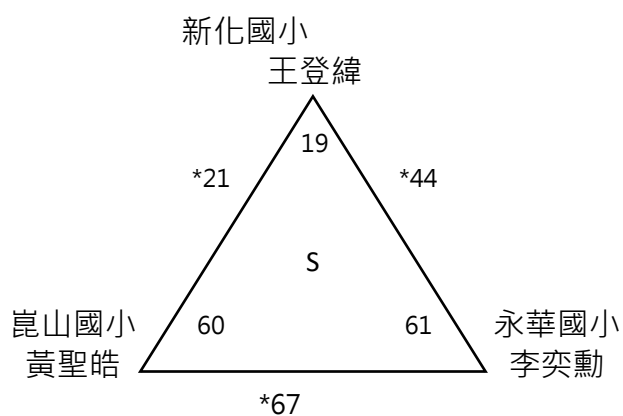
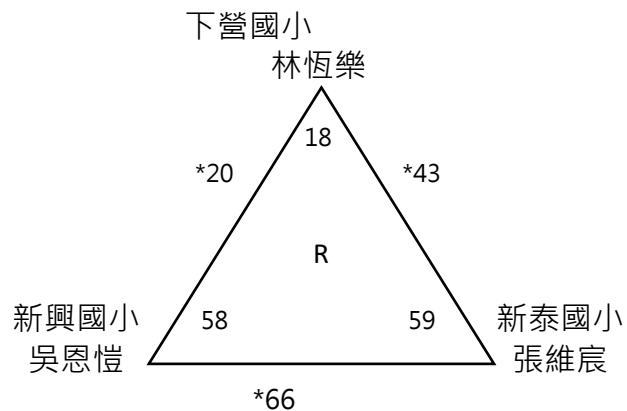
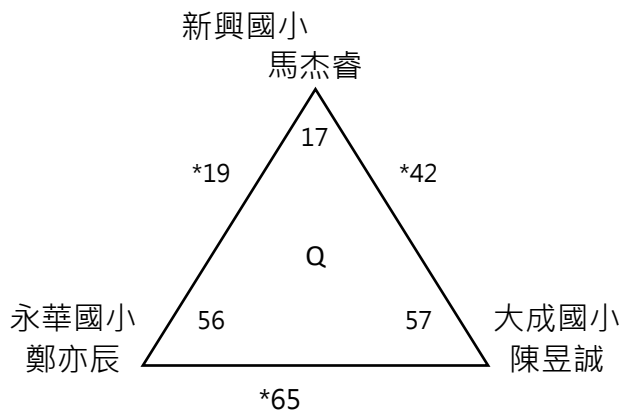

組別 4男單預賽

組數 64 小組3取1、4取2

晉級 22

9月25日

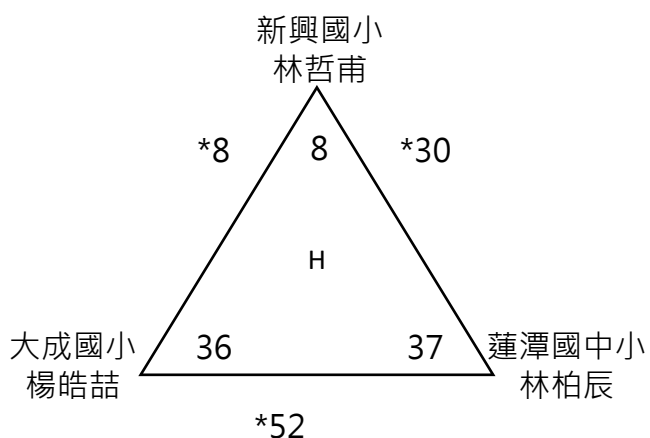
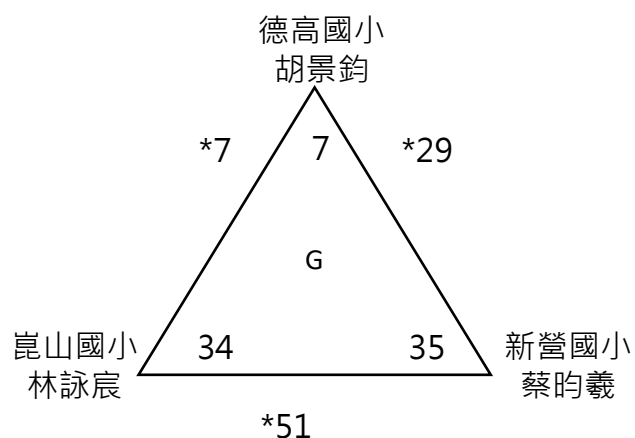
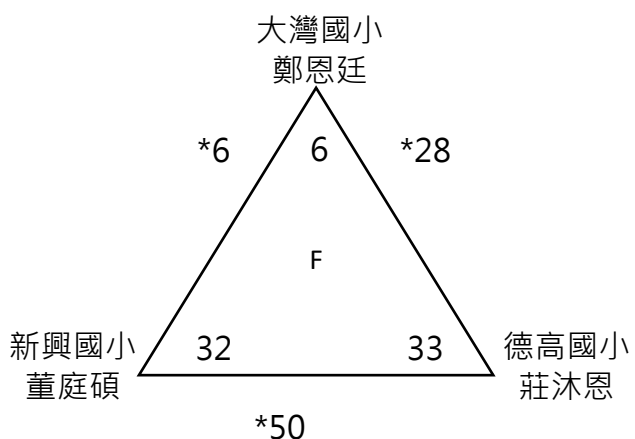
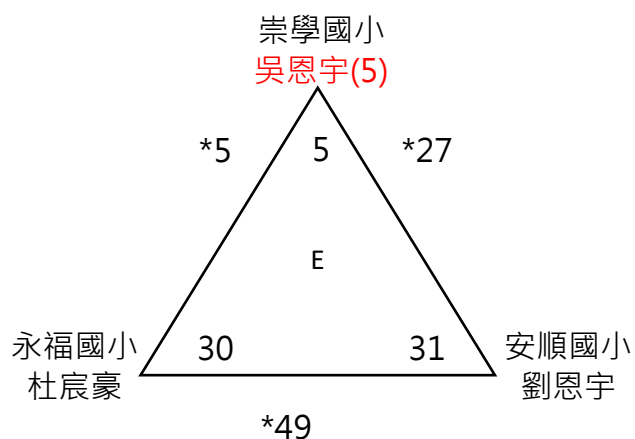
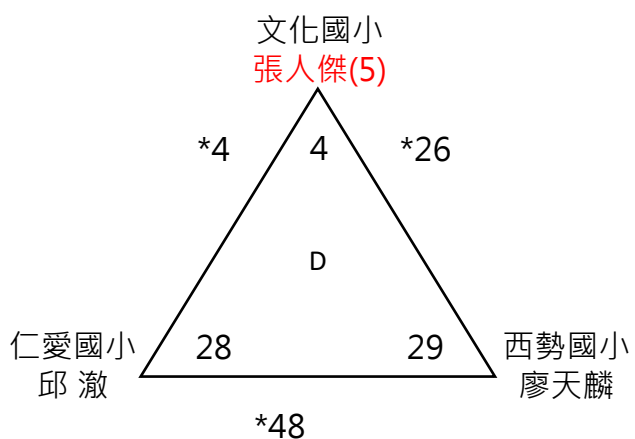
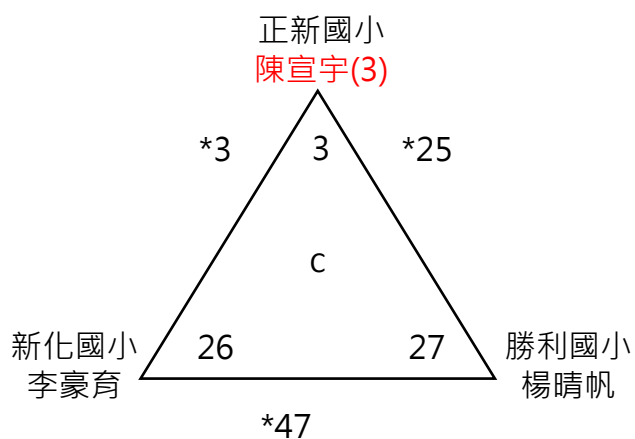
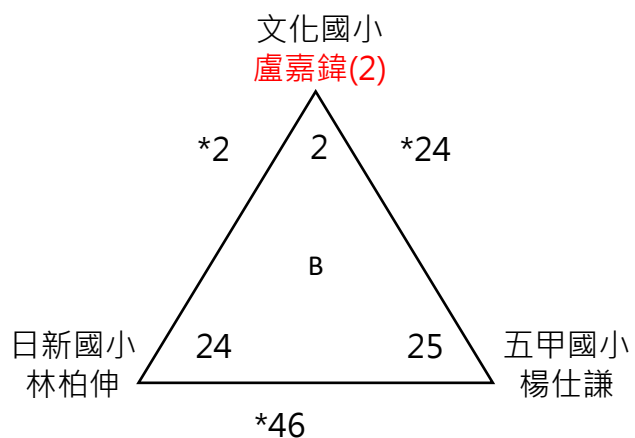
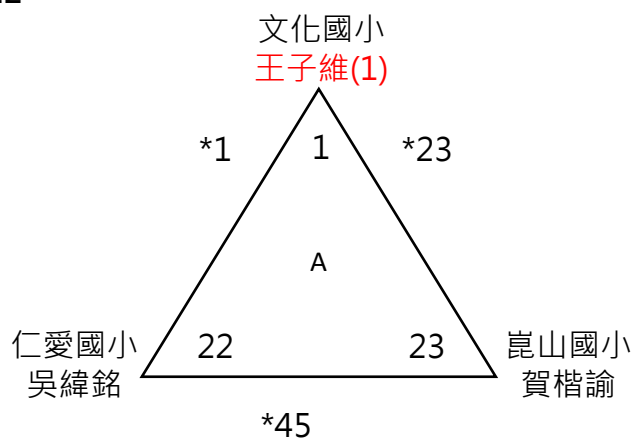

組別 4男單預賽

組數 64 小組3取1、4取2

9月25日

晉級 22

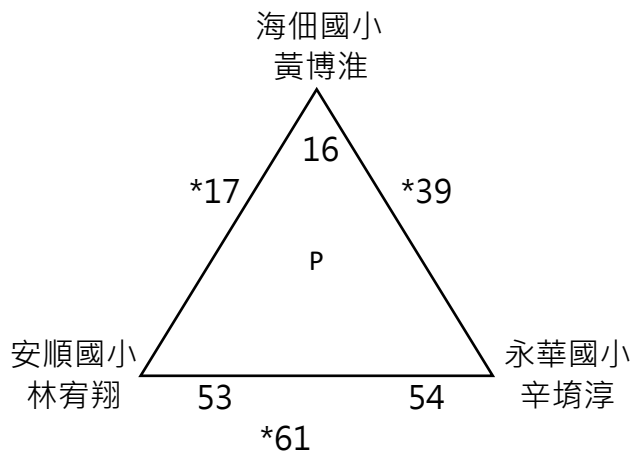
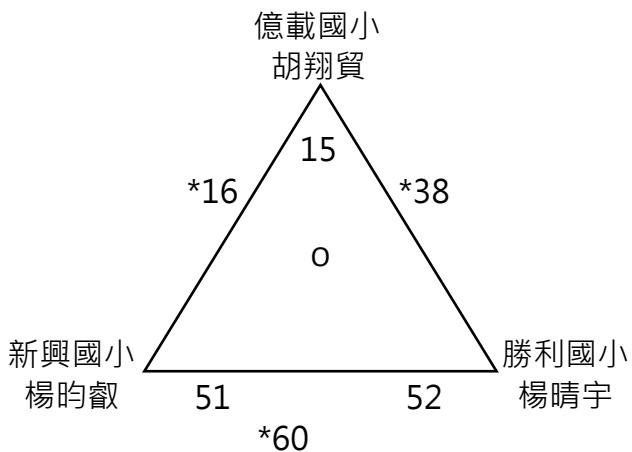
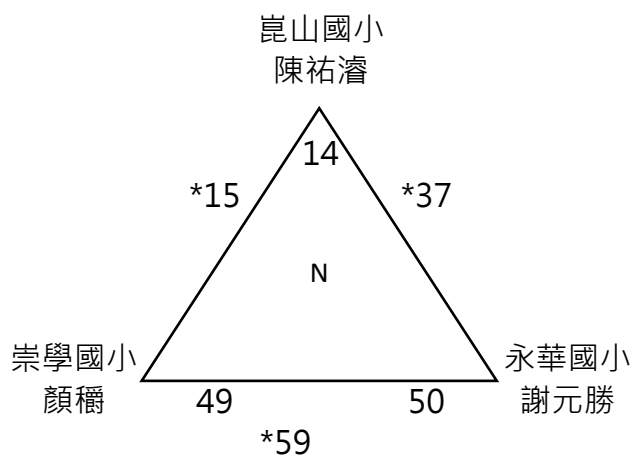
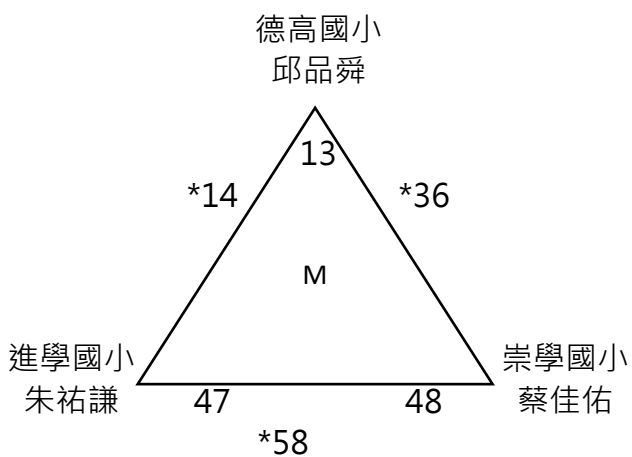
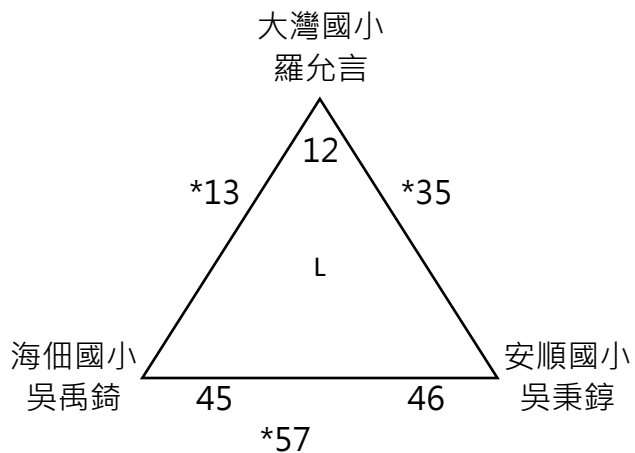
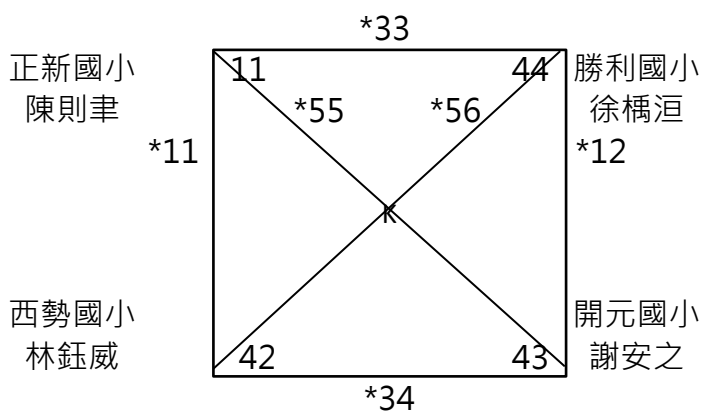
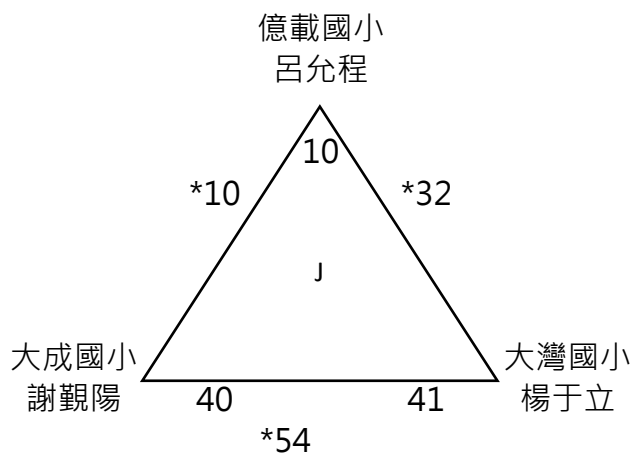
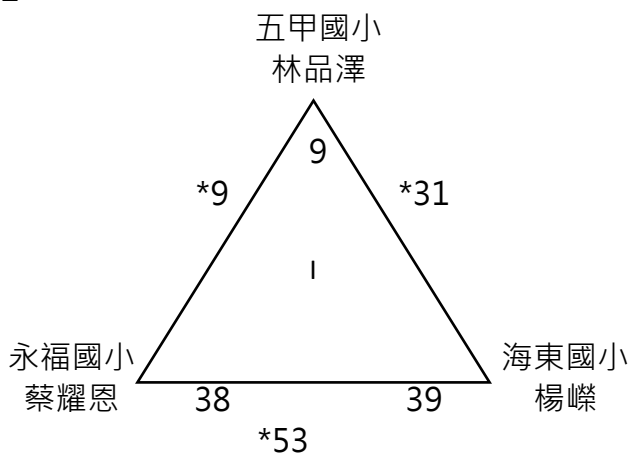

組別 4男單預賽

組數 64 小組3取1、4取2

9月25日

晉級 22

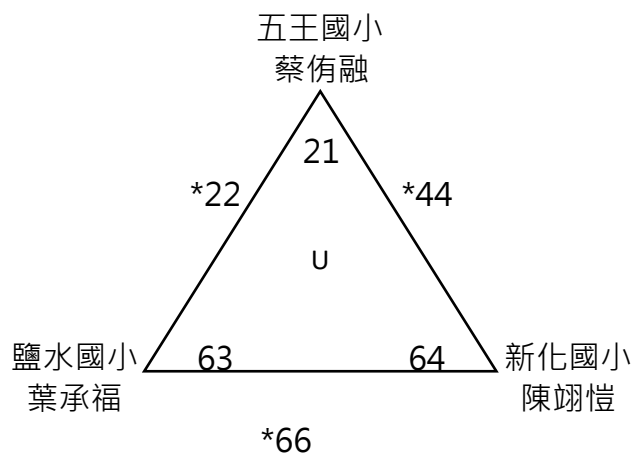
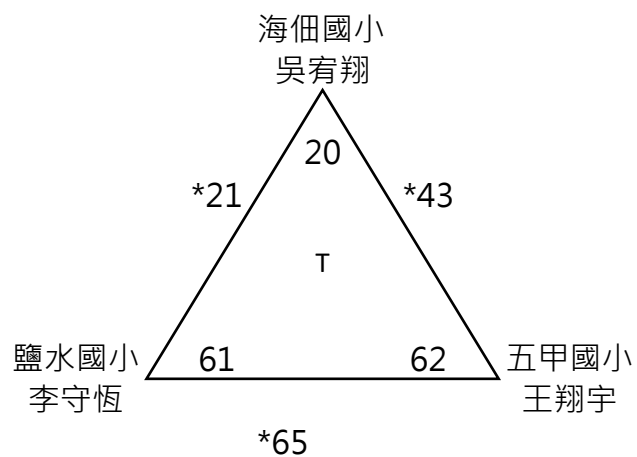
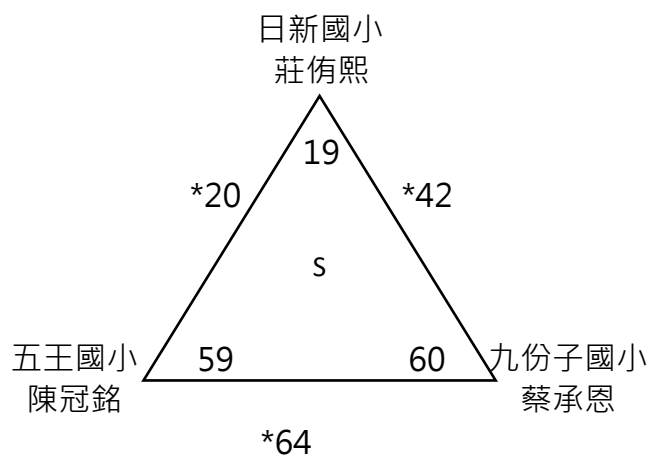
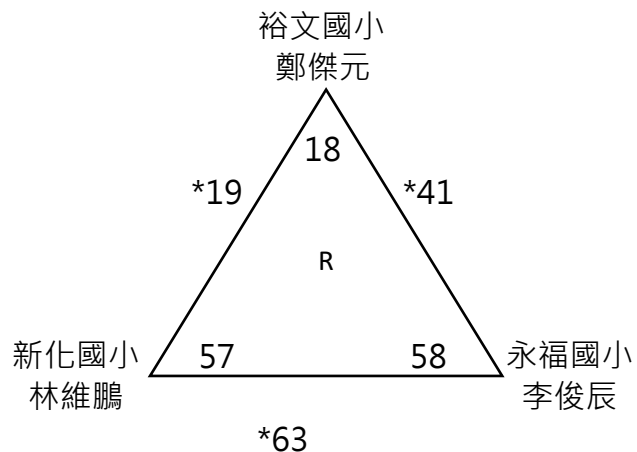
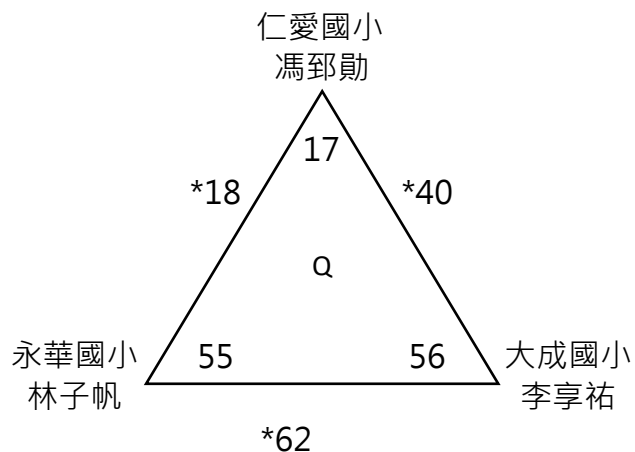

組別: 4男單決
晉級: 22

9月26日
籤號

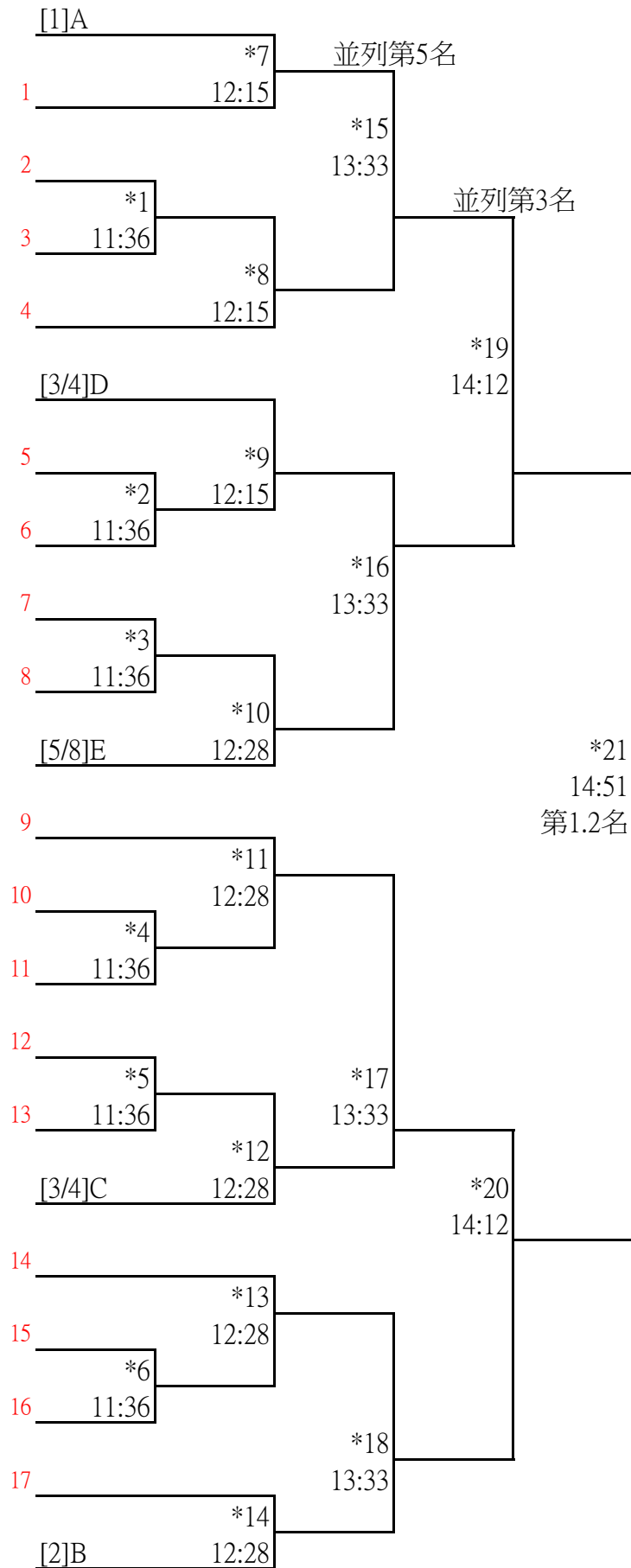

組別 3男單預賽

組數 61 小組3取1、4取2

晉級 21

9月26日

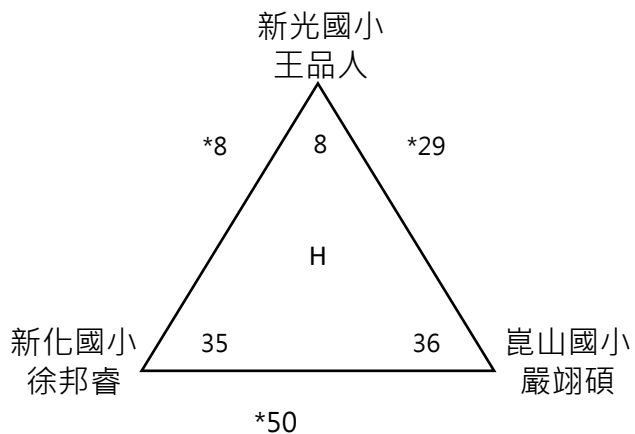
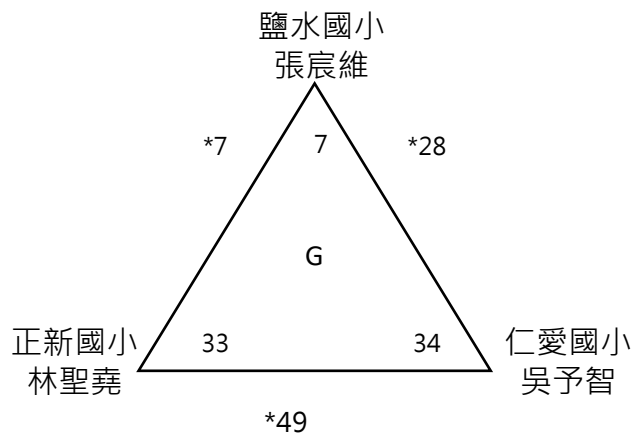
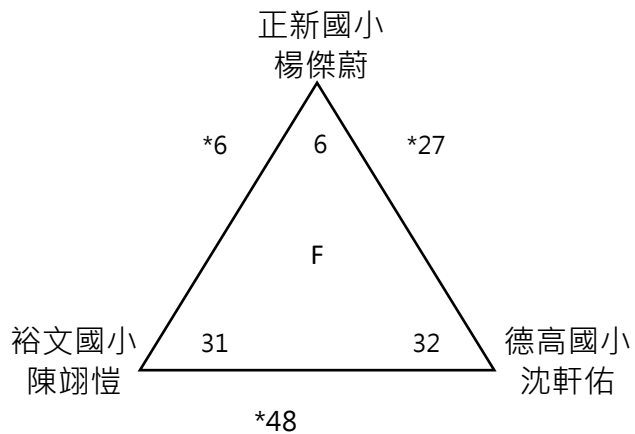
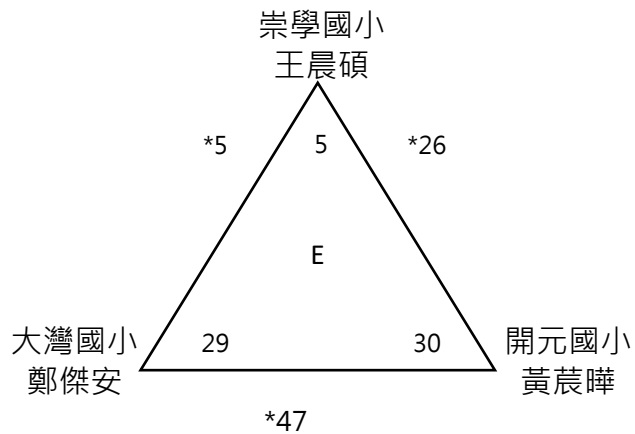
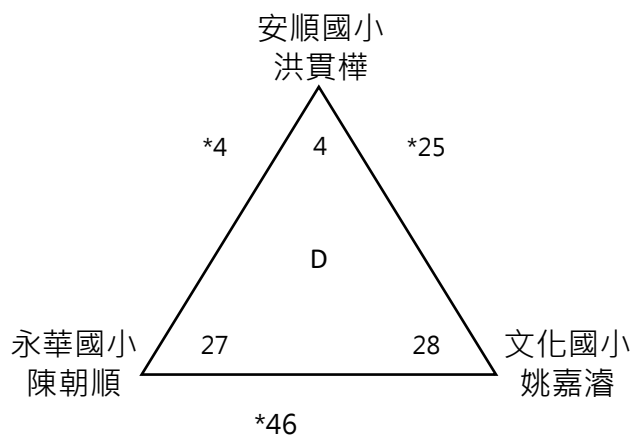
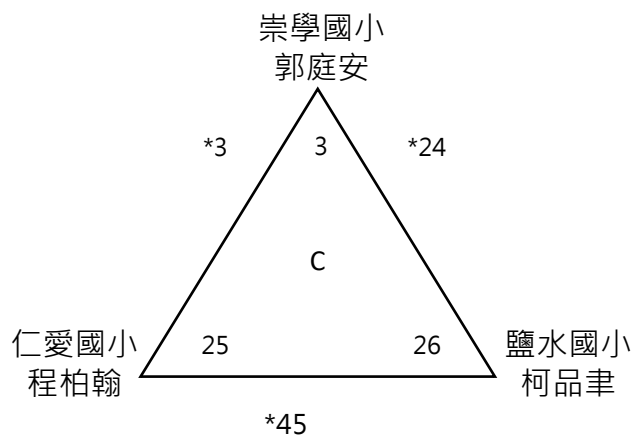
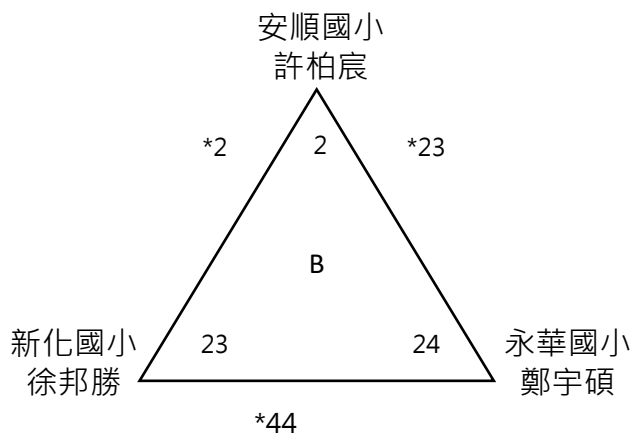
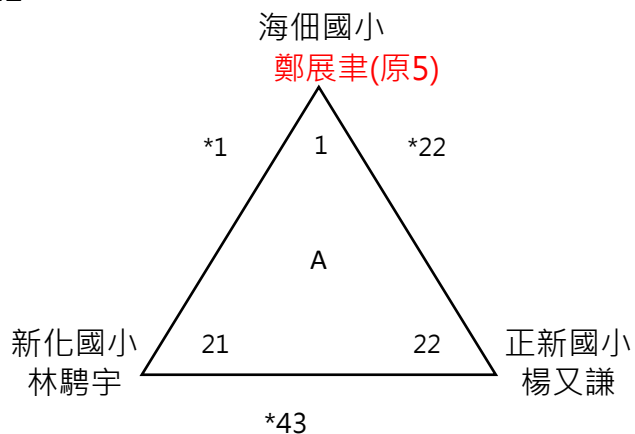

組別 3男單預賽

組數 61 小組3取1、4取2

9月26日

晉級 21

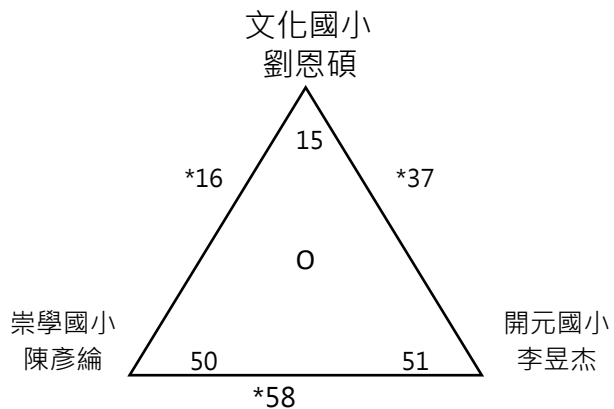
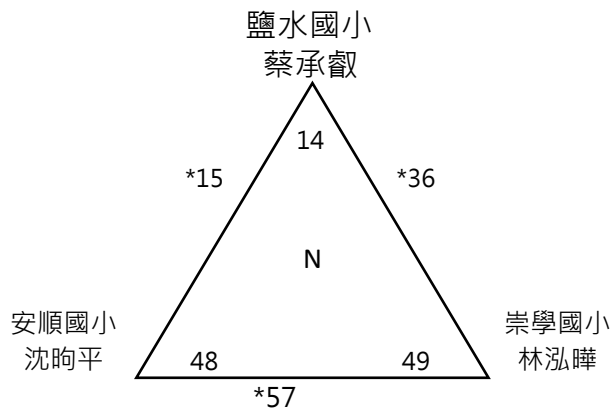
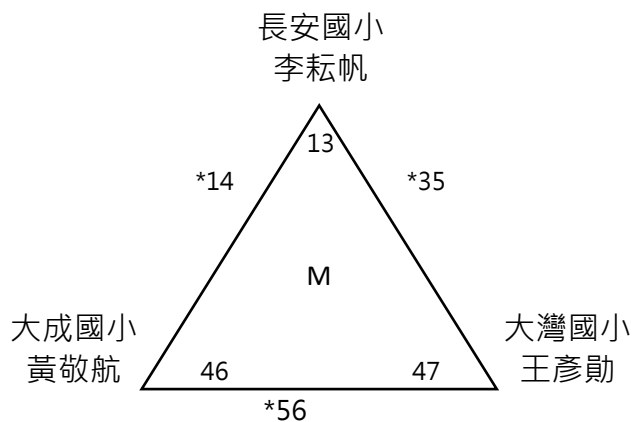
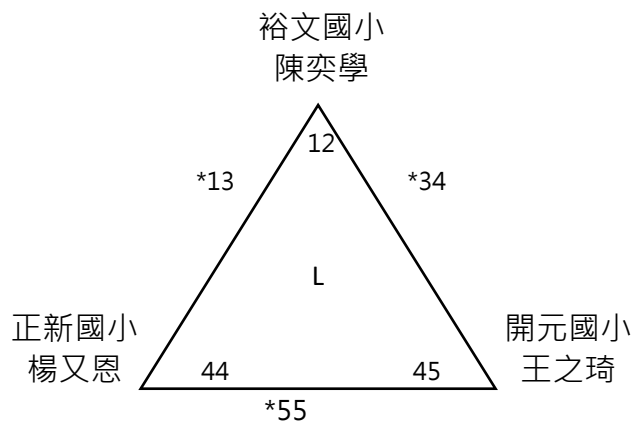
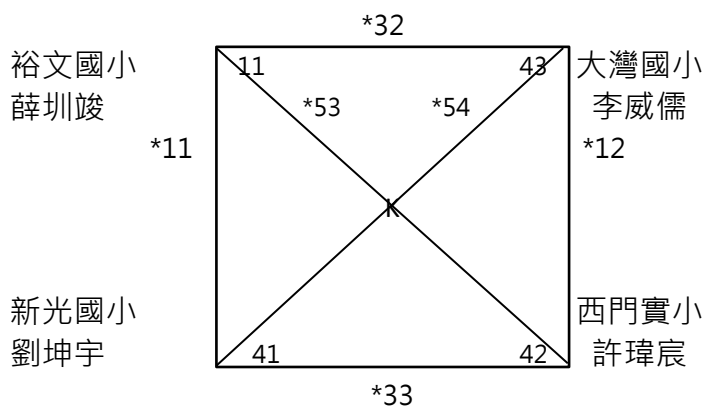
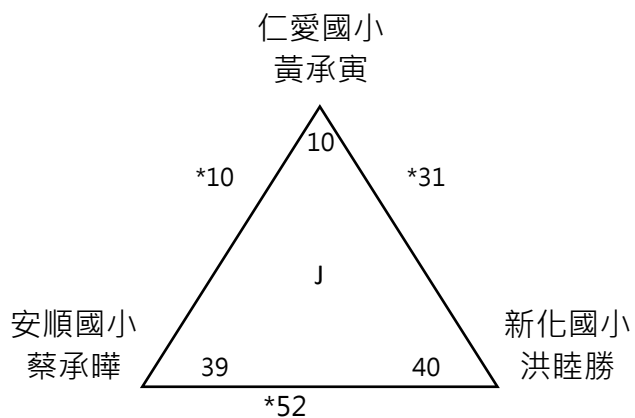
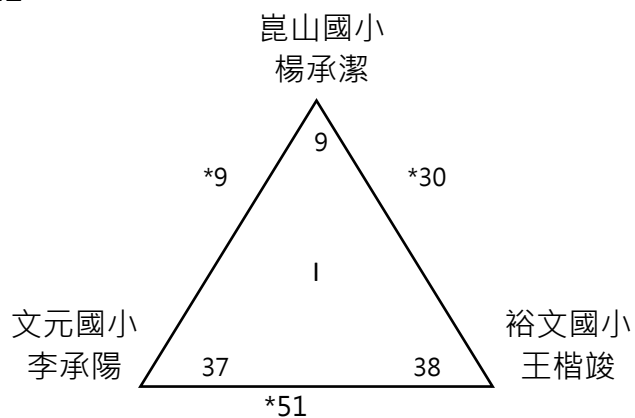

組別 3男單預賽

組數 61 小組3取1、4取2

9月26日

晉級 21

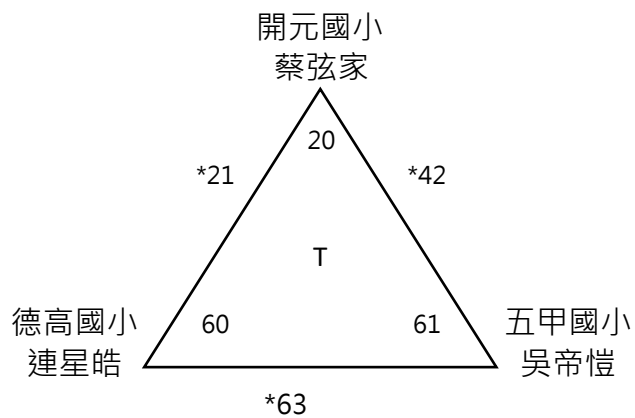
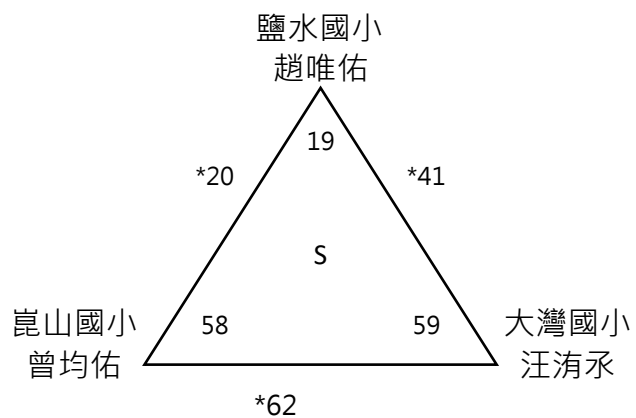
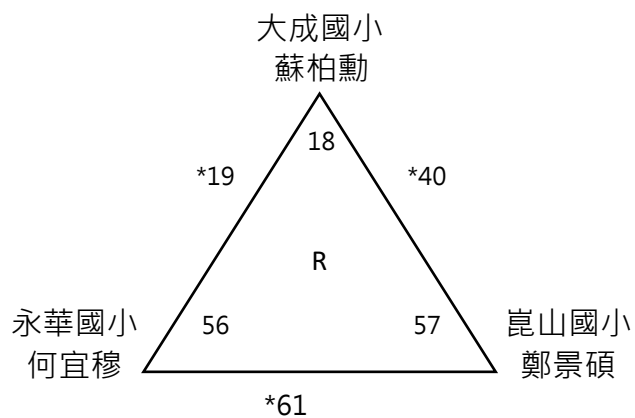
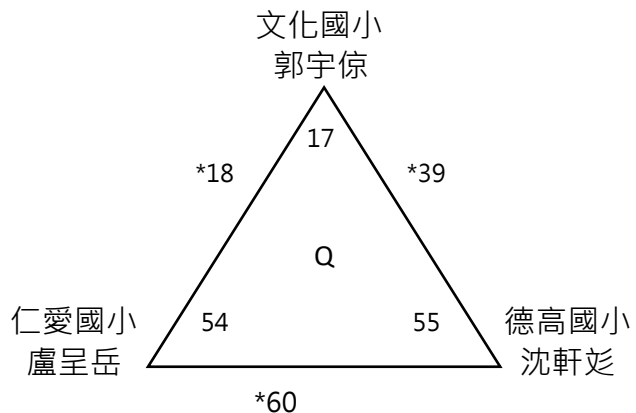
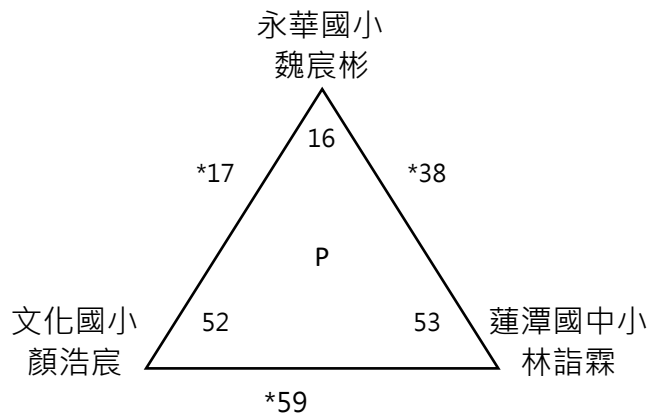

組別: 3男單決
晉級: 21

9月26日
籤號

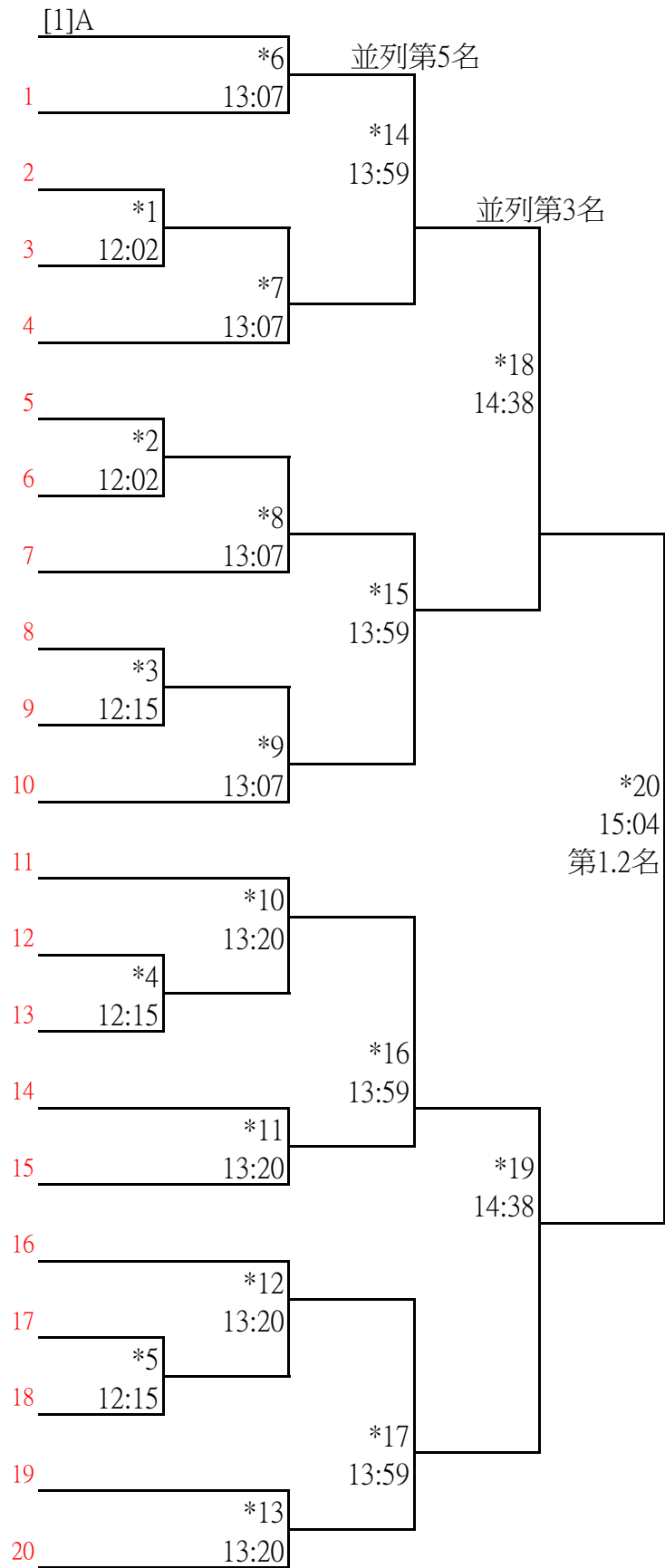

組別: 6男雙
敗部:

21組,取8名

賽制:雙敗淘汰制
9月24日

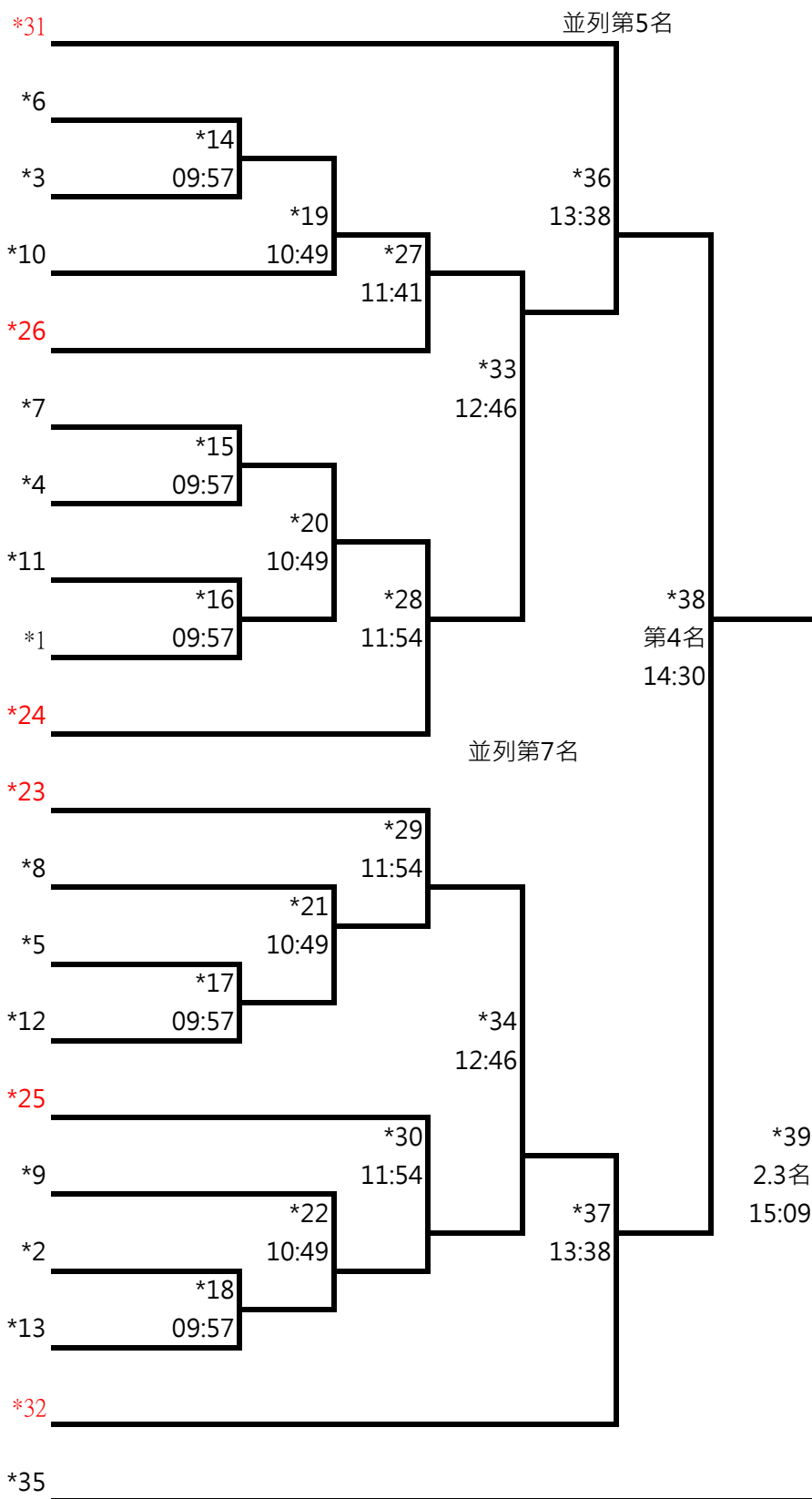

組別 5男雙

組數 26 小組3取1、4取2

9月24日

晉級 10

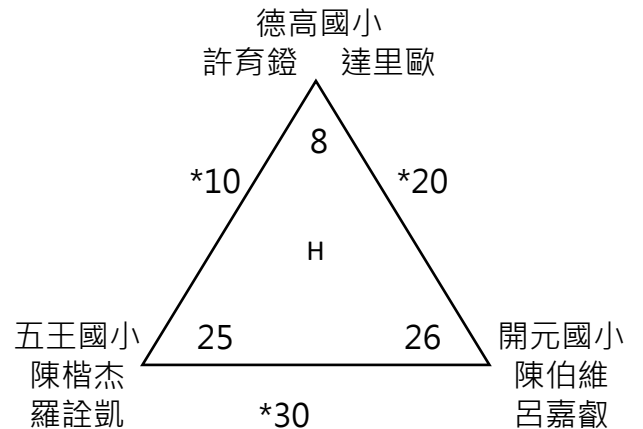
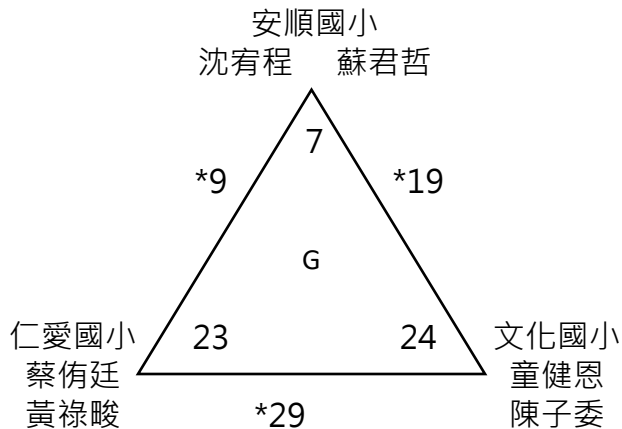
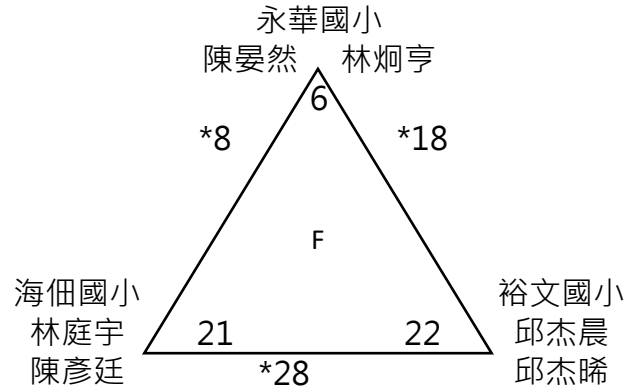
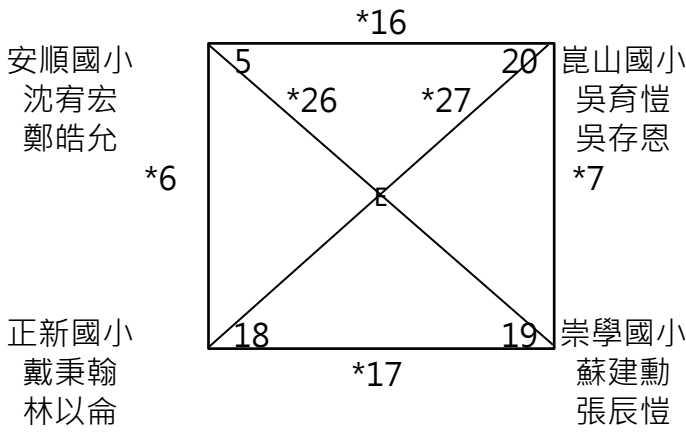
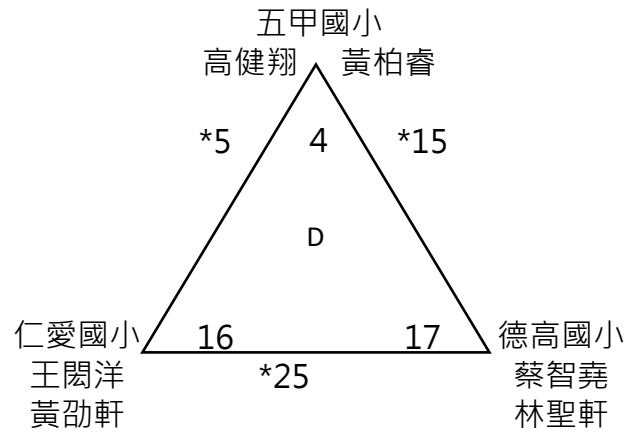
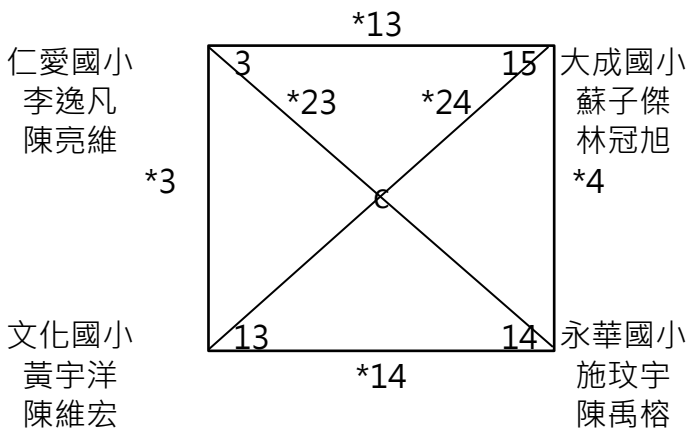
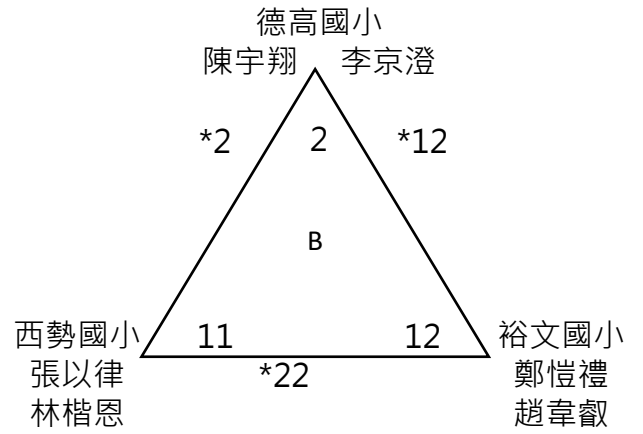
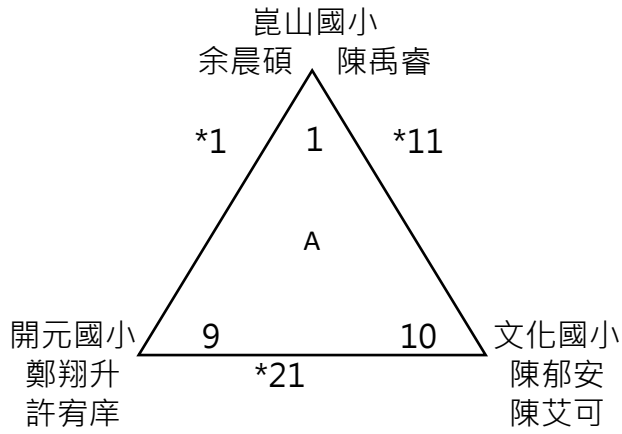

組別: 5男雙決

9月24日

晉級: 10

籤號

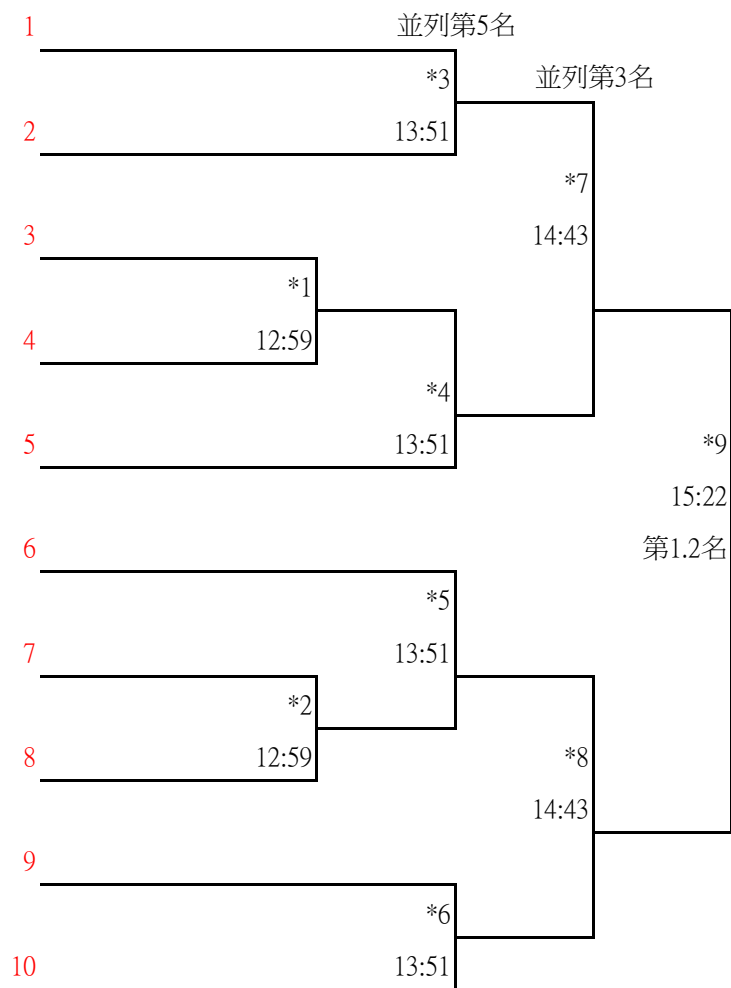

組別: 6女雙 7組
 賽制:雙敗淘汰制 9月24日

勝部:



敗部:

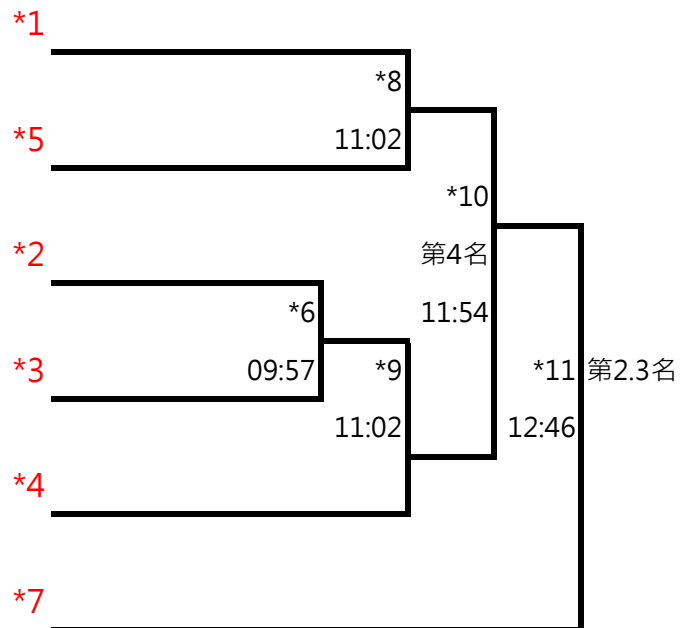

組別: 5女雙
5組

9月26日

