

組別 國女單 預賽
組數 37 小組3取1、4取2
晉級 13

9月22日

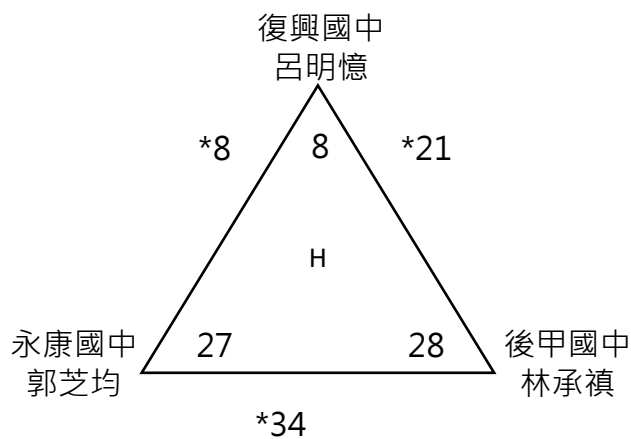
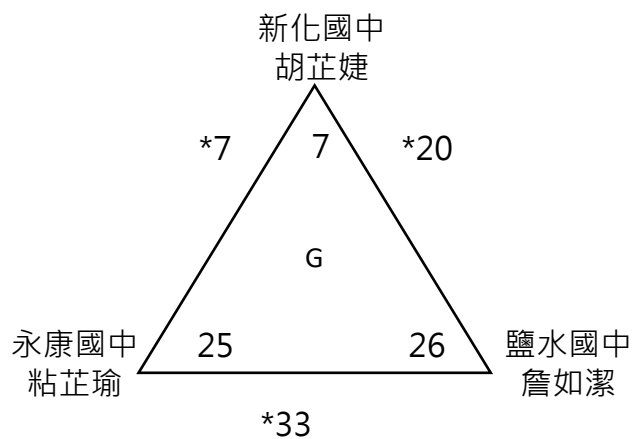
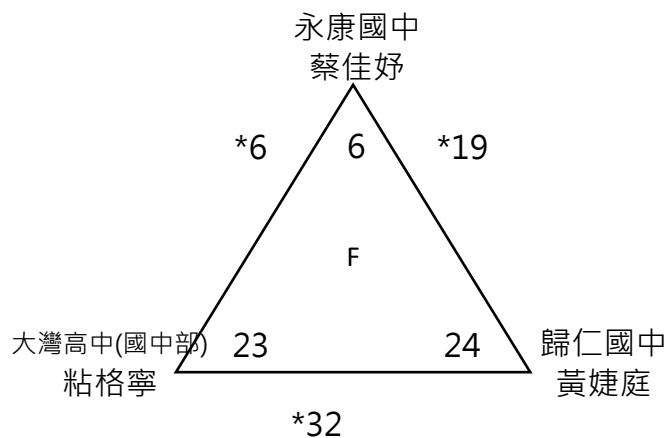
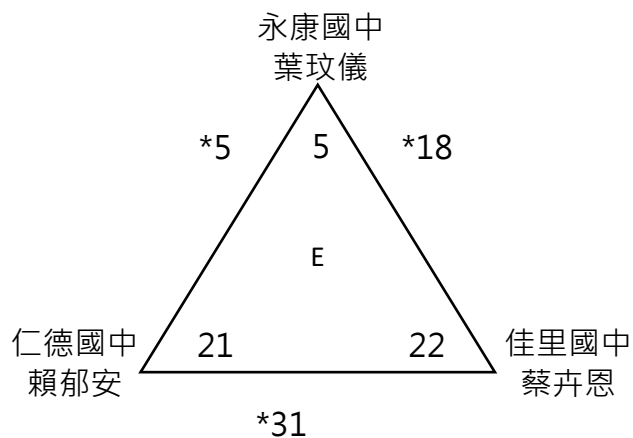
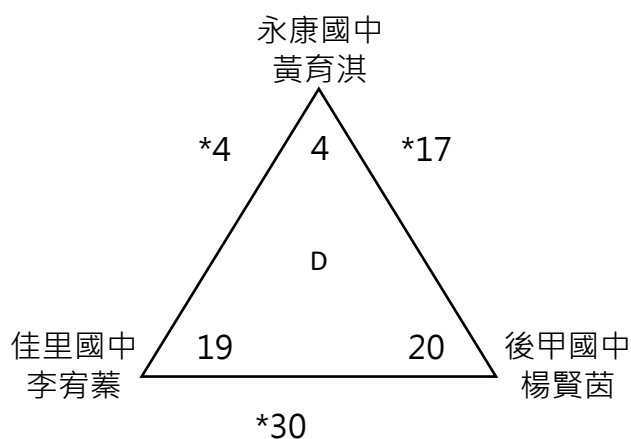
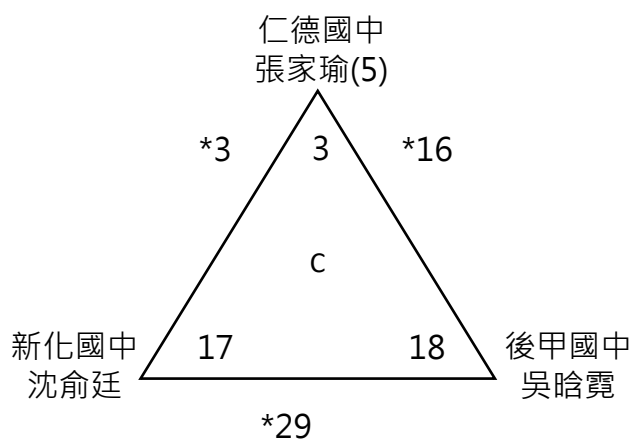
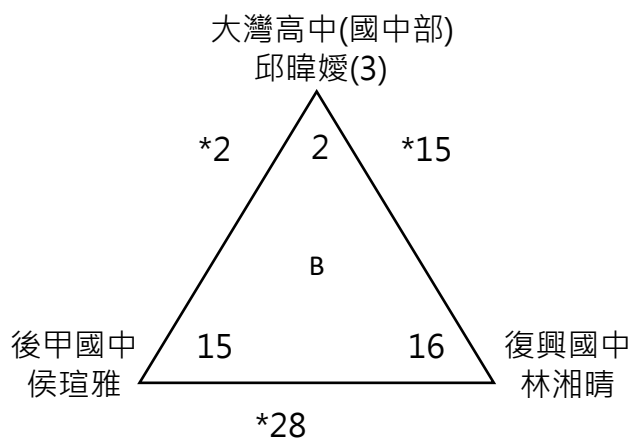
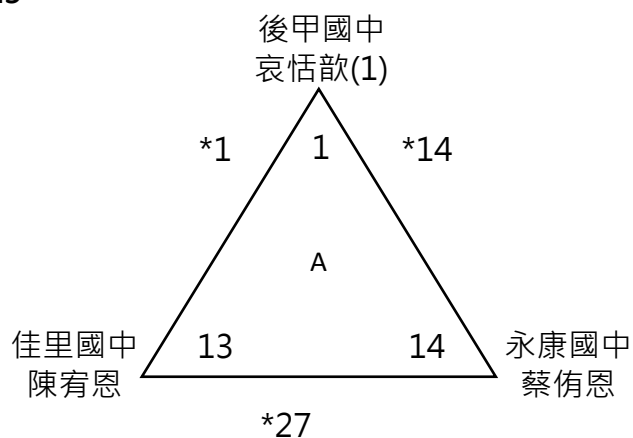

組別 國女單 預賽
 組數 37 小組3取1、4取2
 晉級 13

9月22日

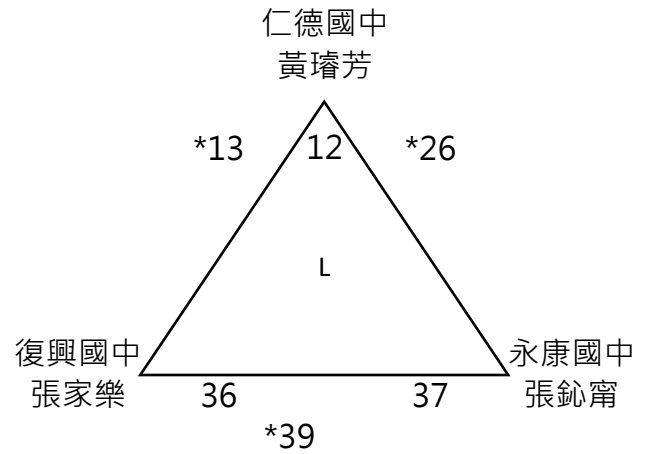
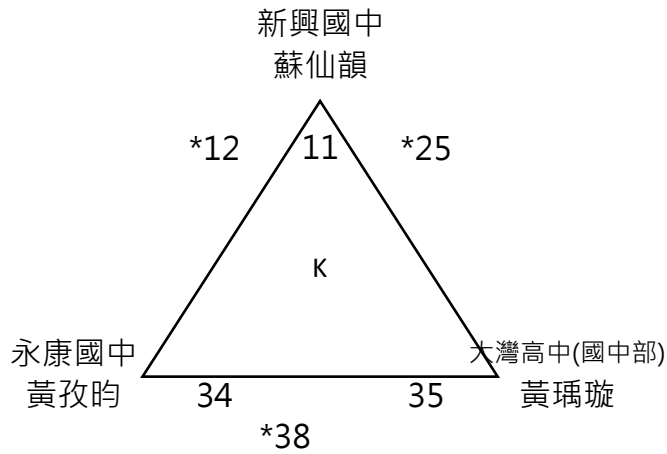
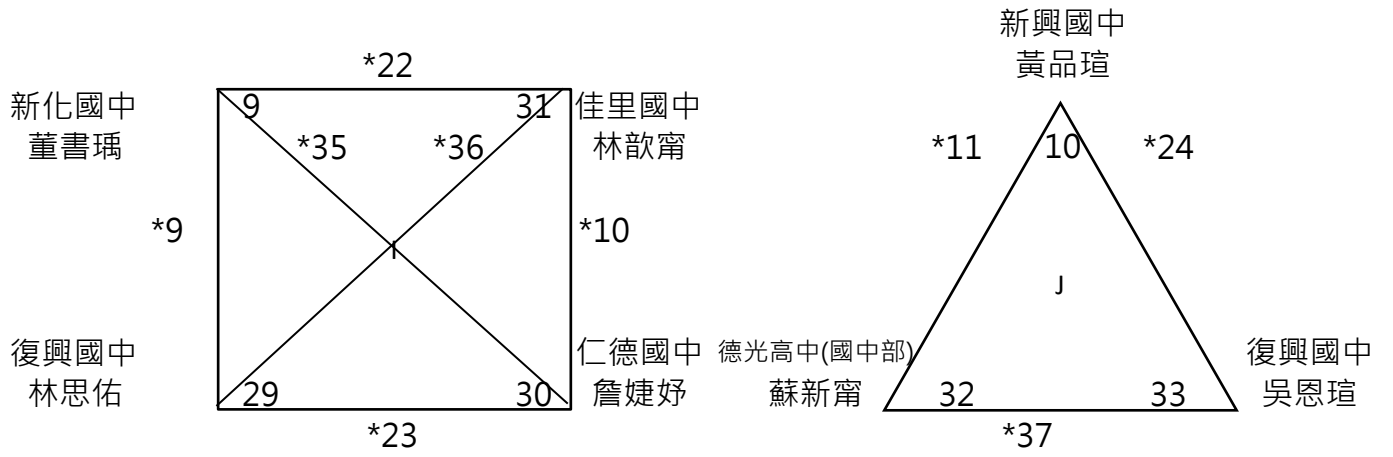

組別: 國女單決 9月23日
晉級: 13

籤號

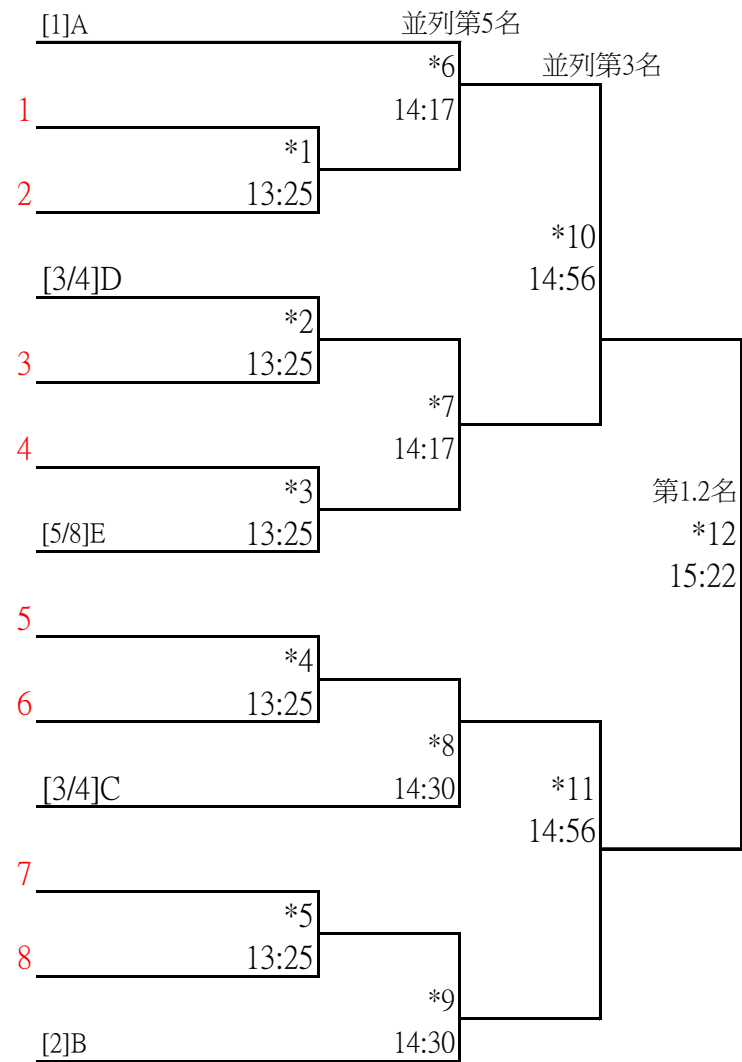

組別: 國女雙 17組,取8名

賽制:雙敗淘汰制

勝部:

9月22日

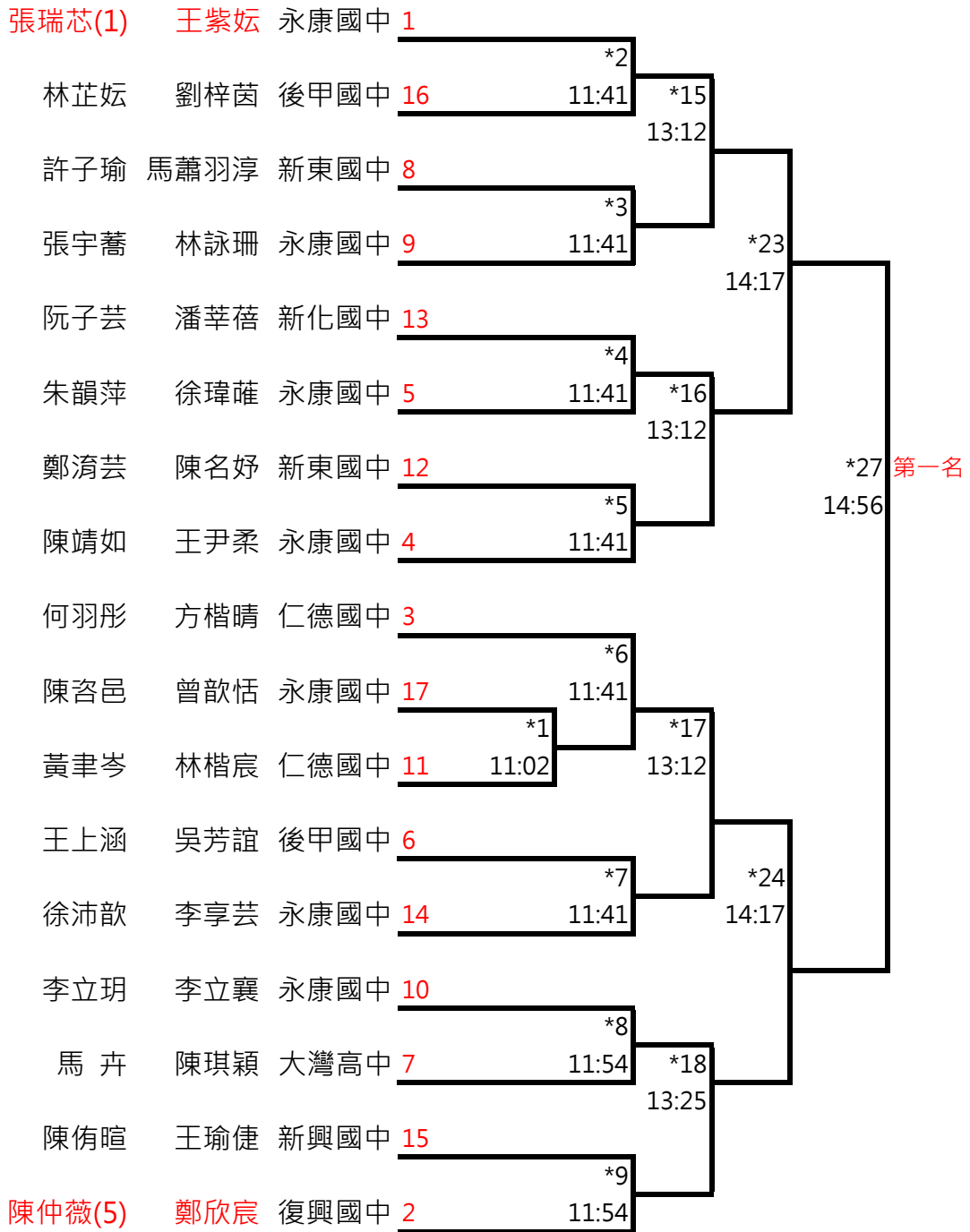

組別: 國女雙 17組,取8名
敗部:

賽制:雙敗淘汰制

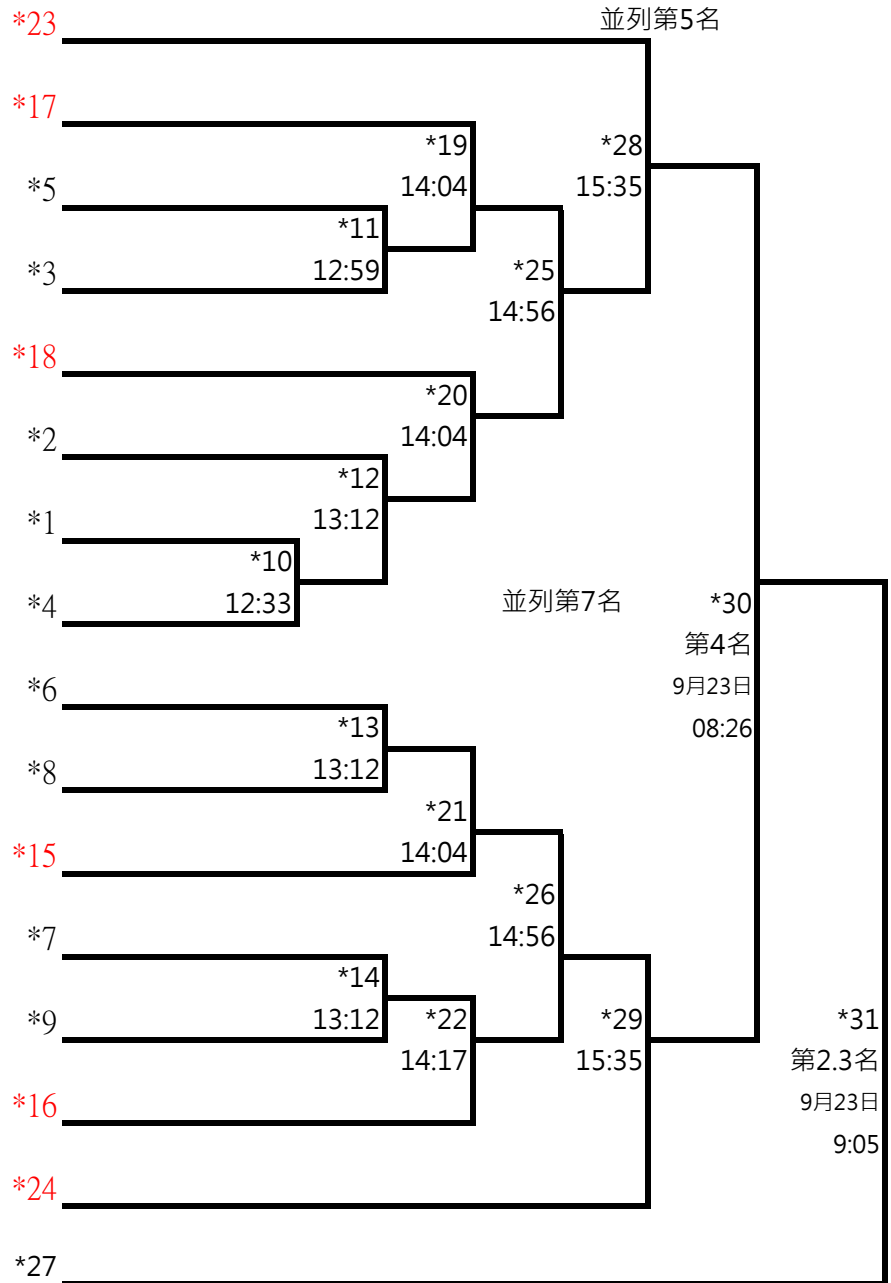

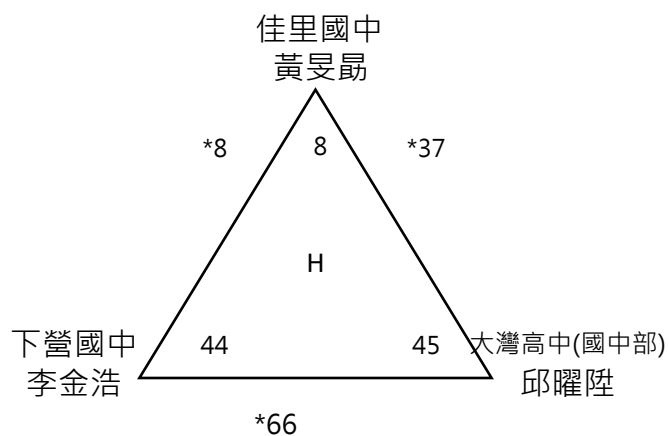
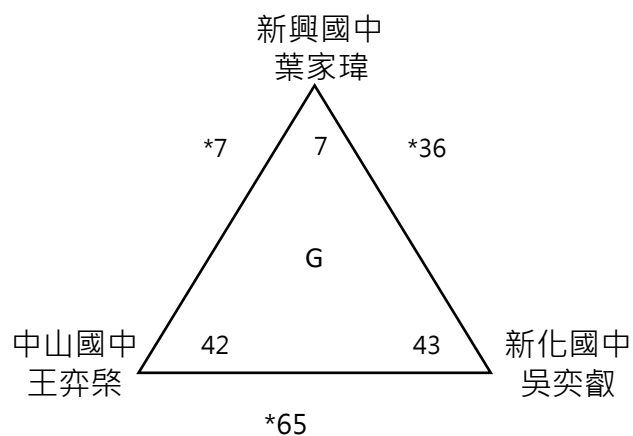
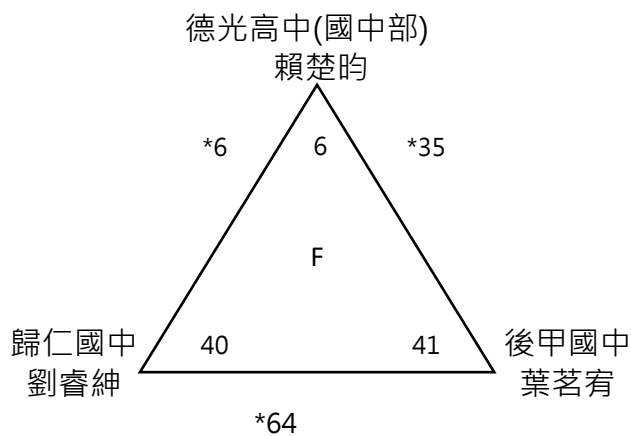
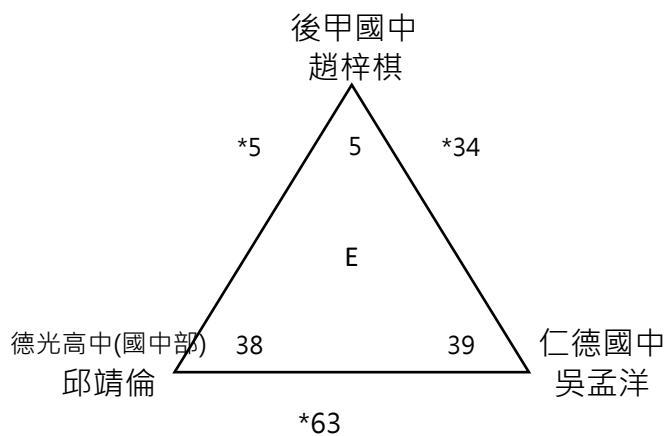
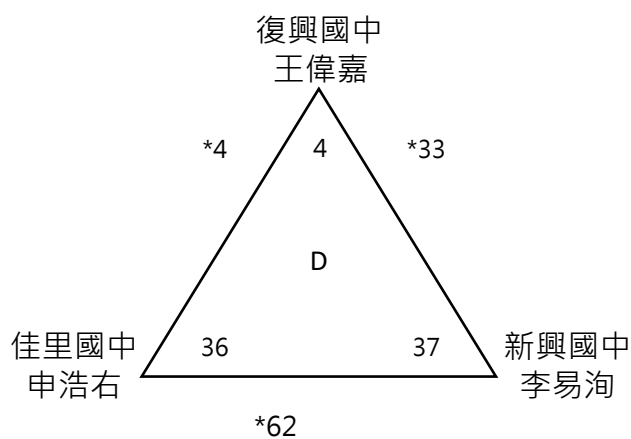
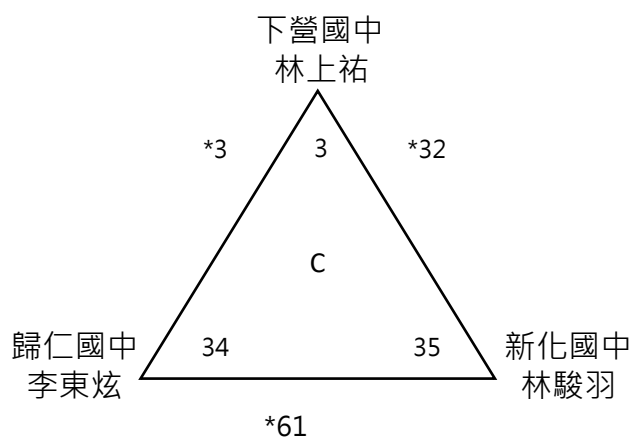
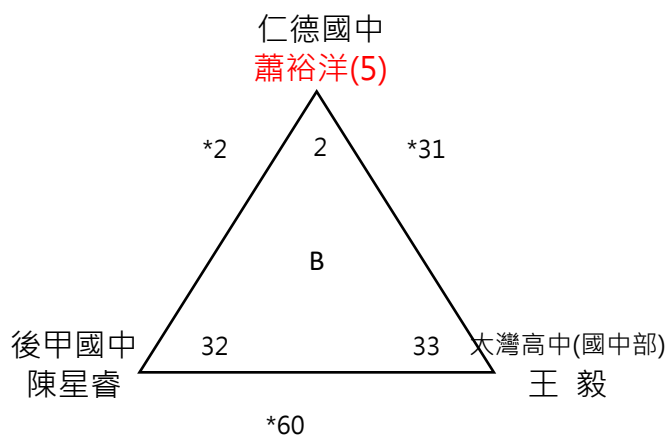
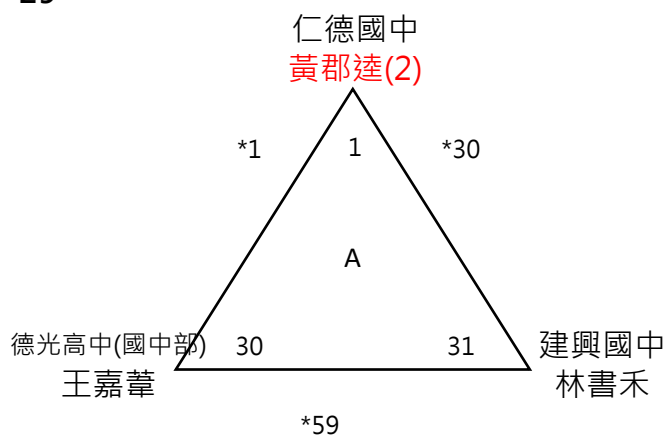

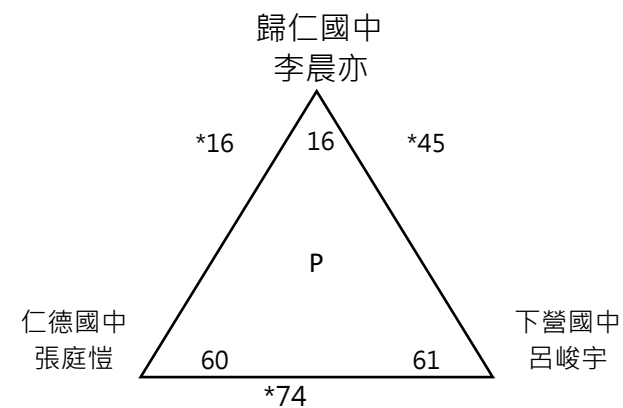
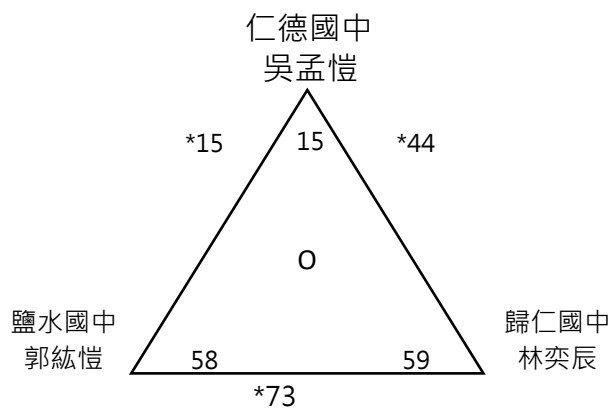
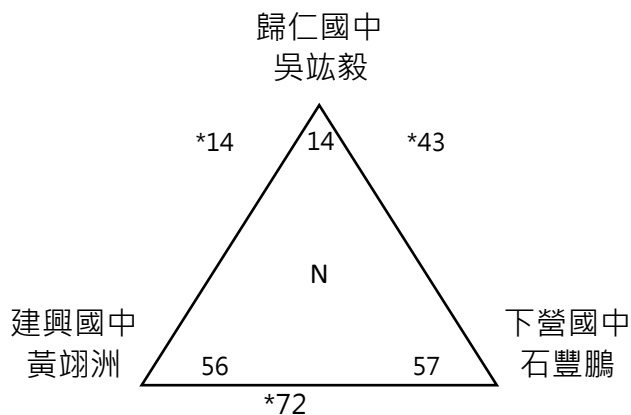
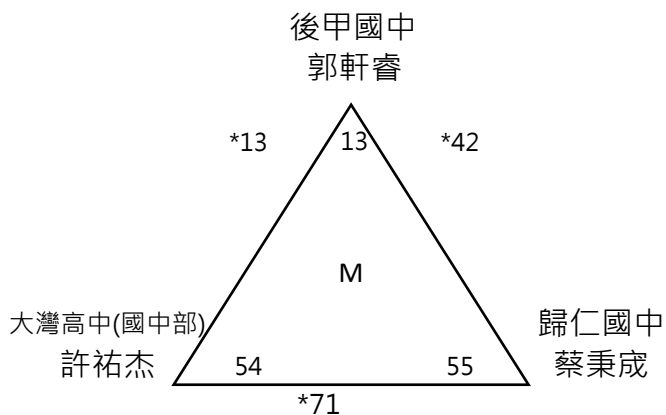
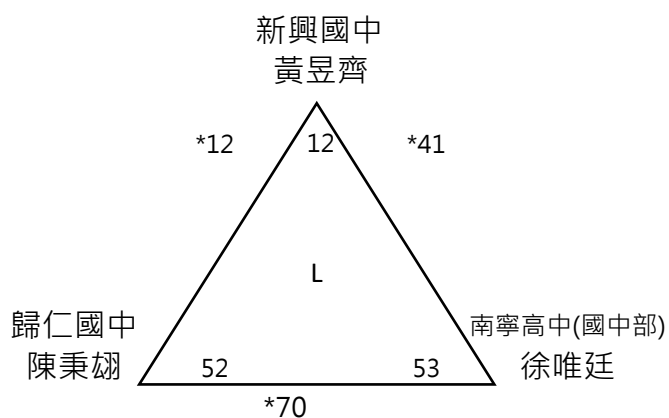
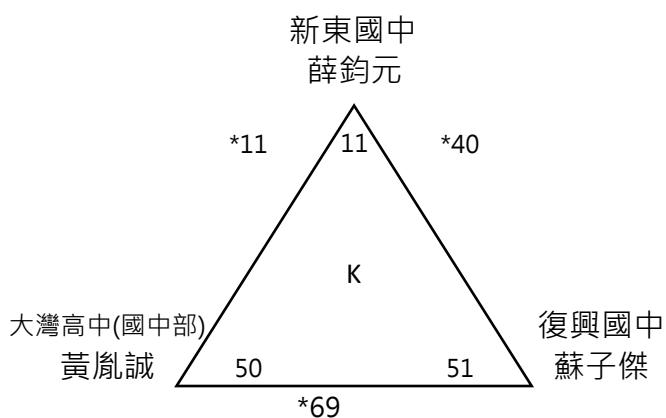
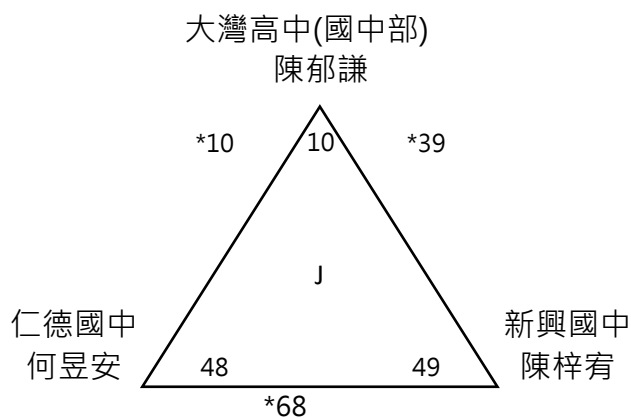
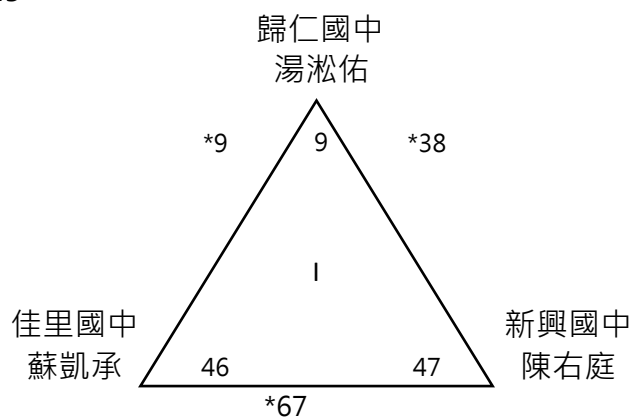

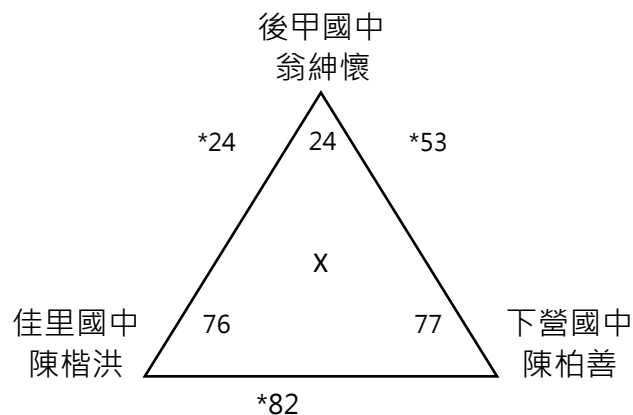
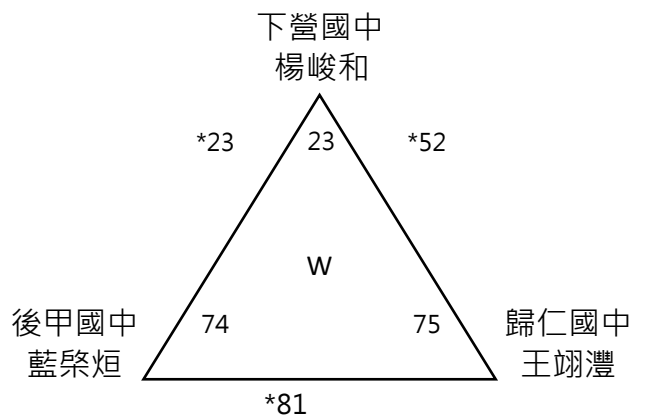
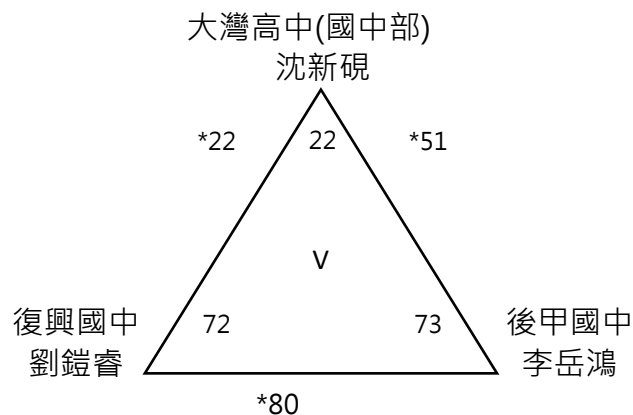
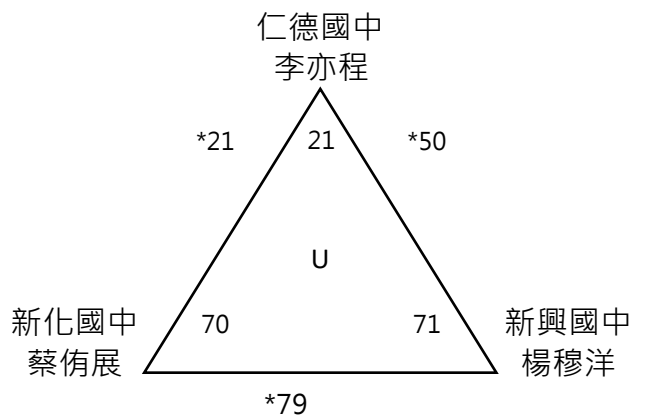
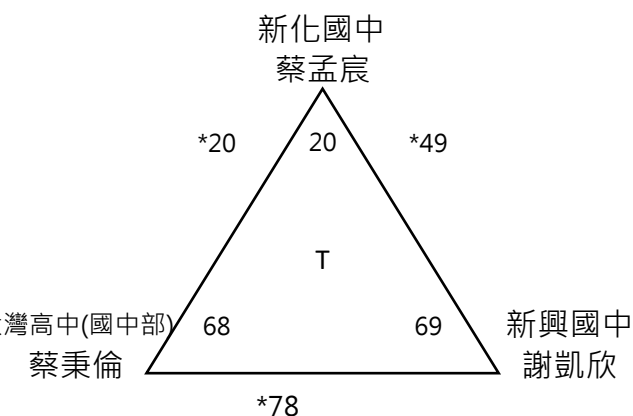
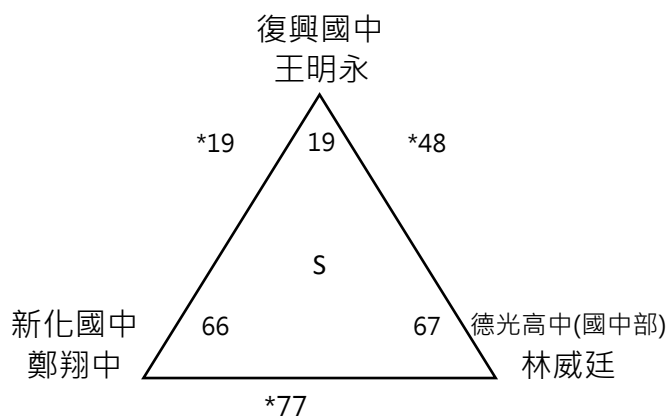
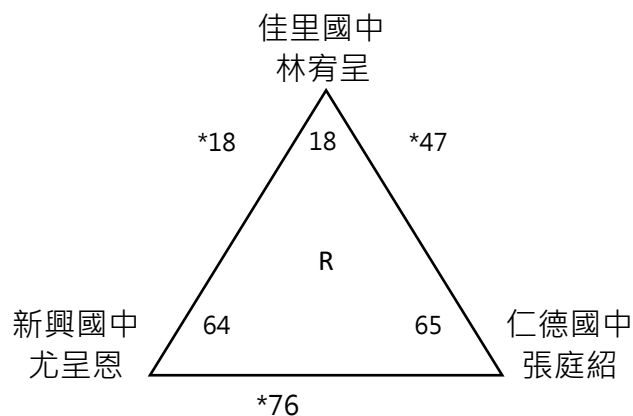
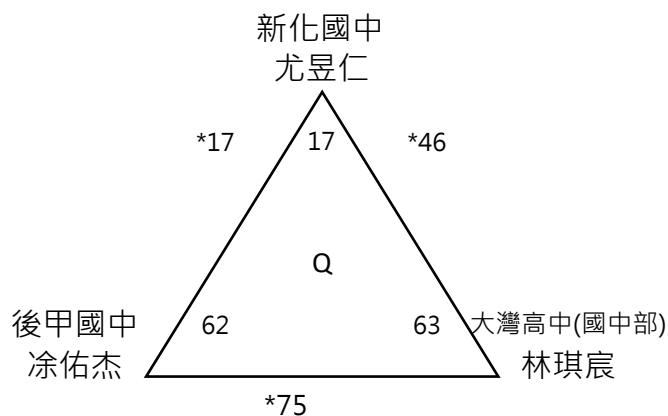

組別 國男單 預賽
 組數 87組 小組3取1、4取2
 晉級 29

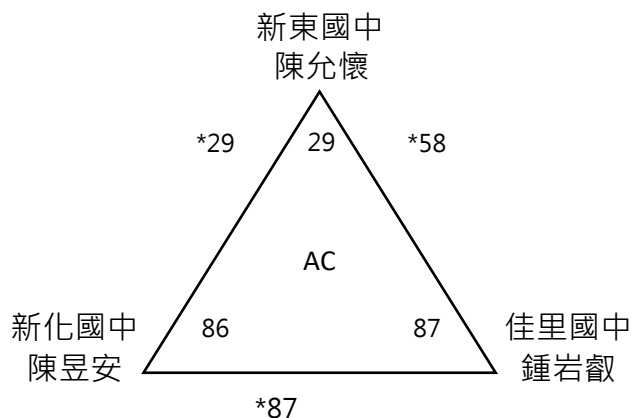
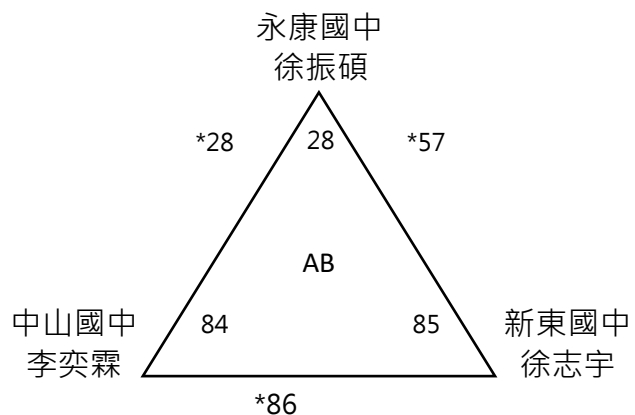
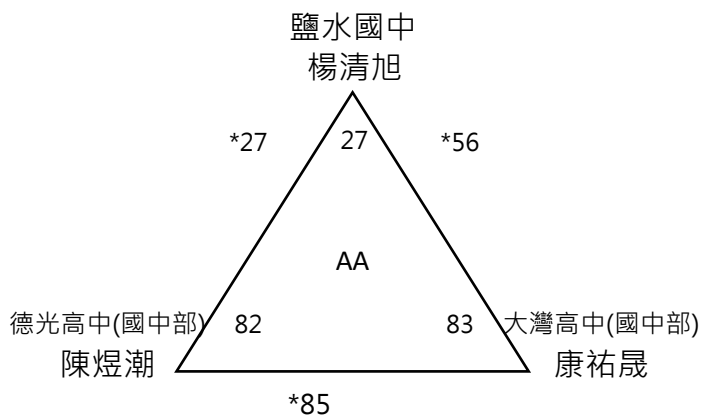
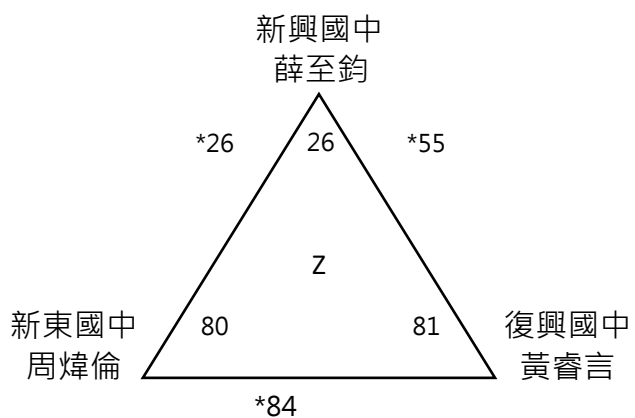
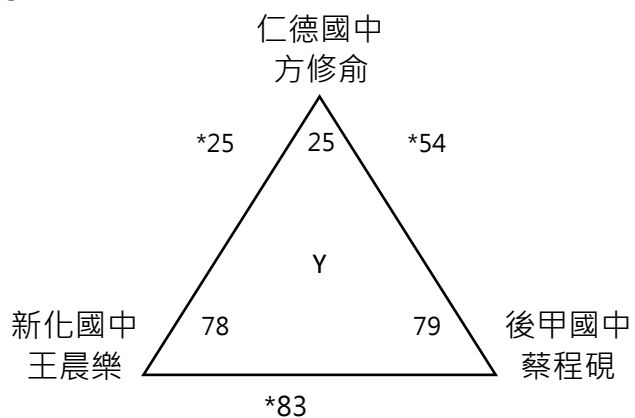

組別: 國男單決
晉級: 29

9月23日

籤號

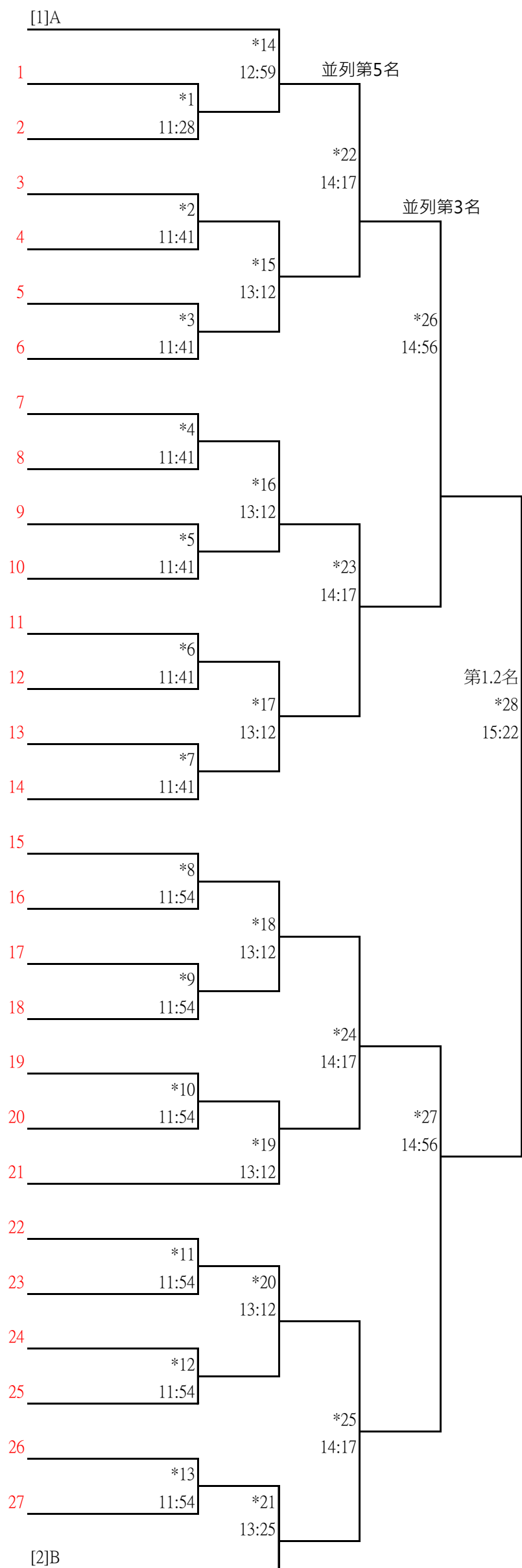

組別 國男雙 預賽
 組數 56 小組3取1、4取2
 晉級 20

9月22日

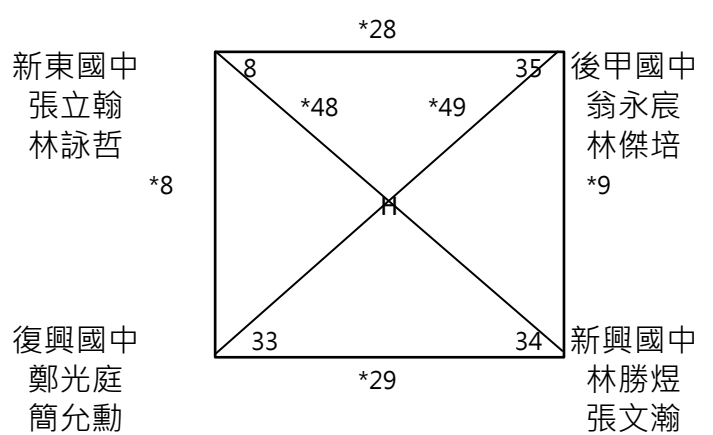
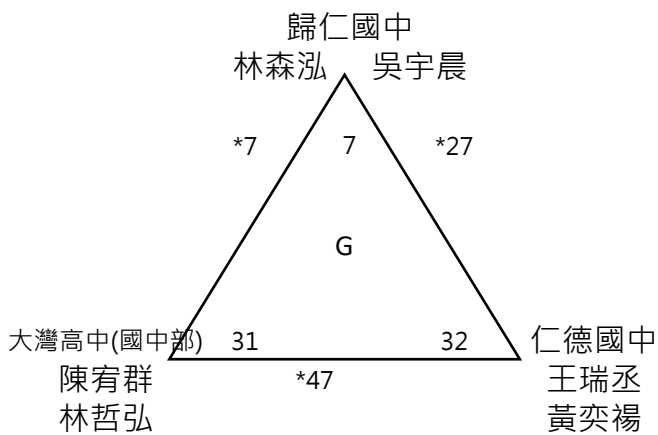
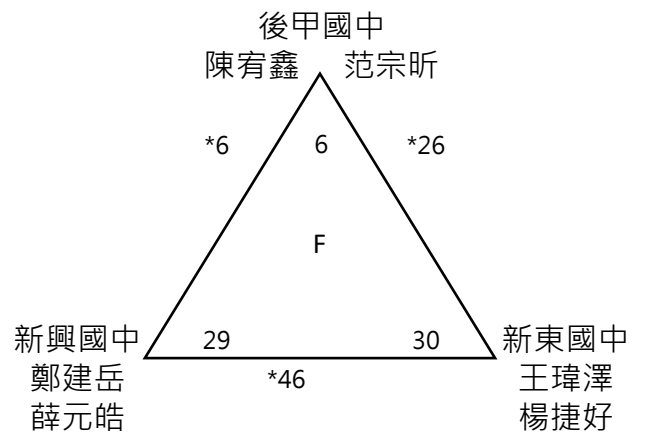
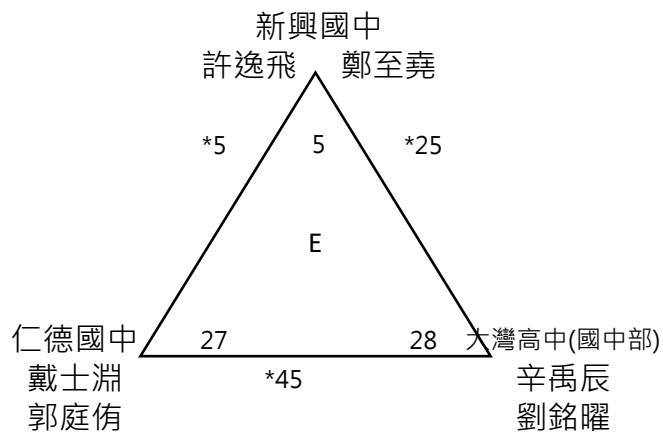
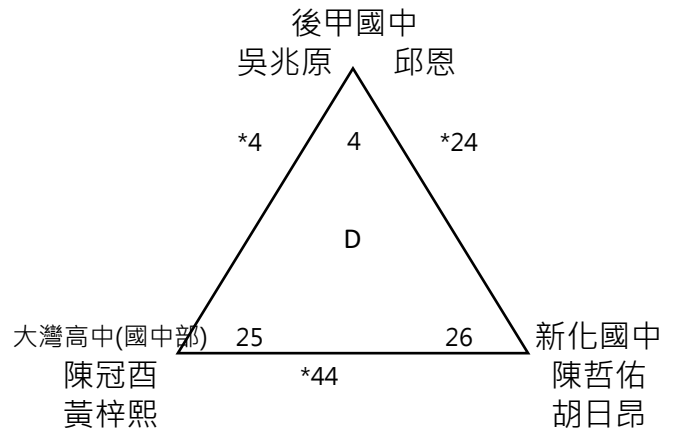
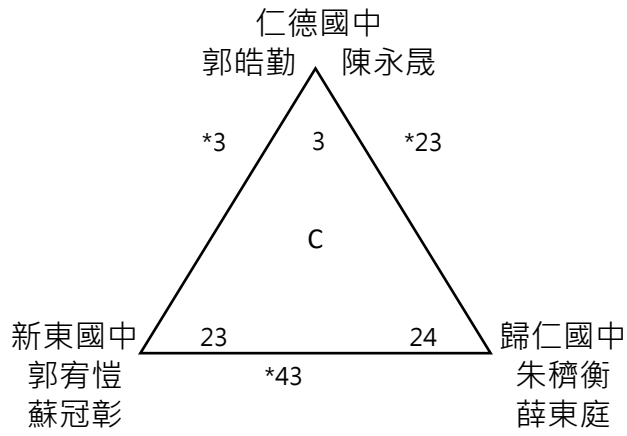
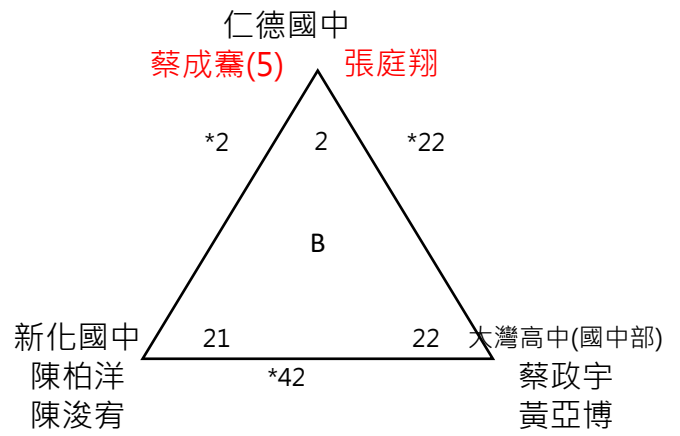
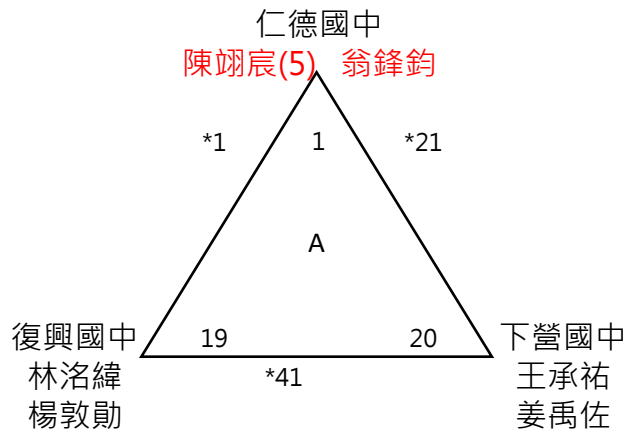

組別 國男雙 預賽

組數 56 小組3取1、4取2
晉級 20

9月22日

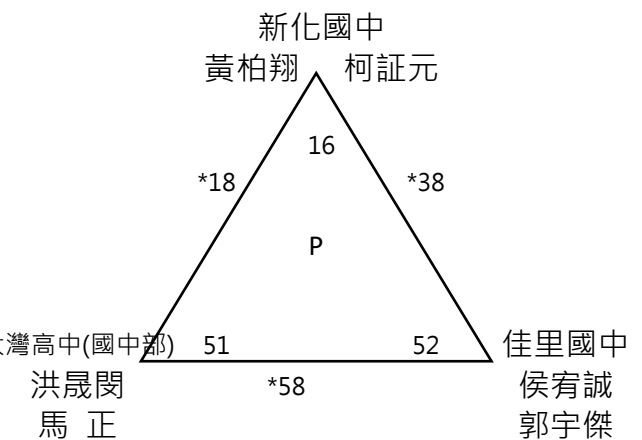
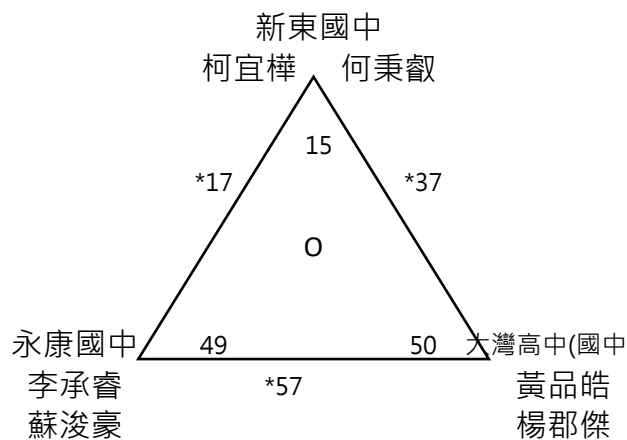
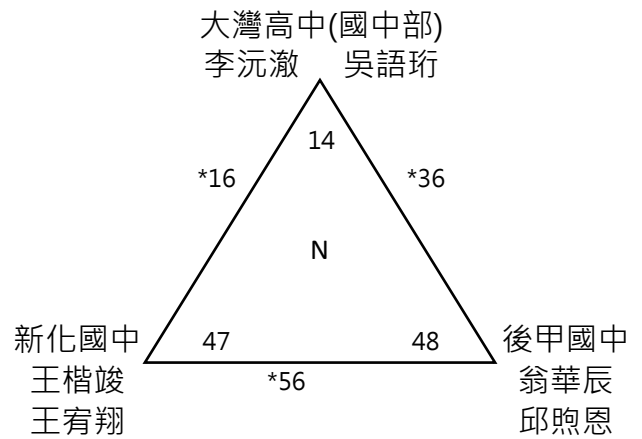
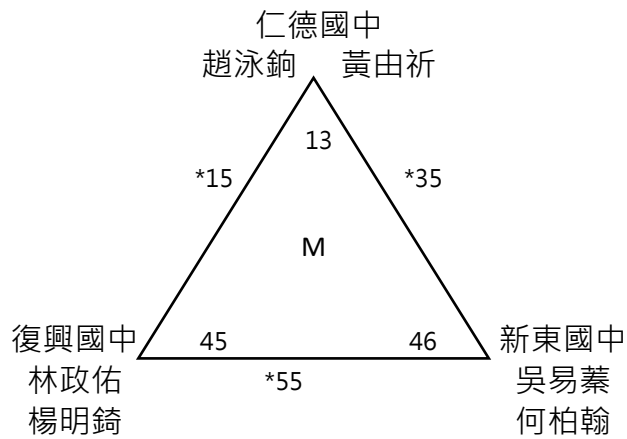
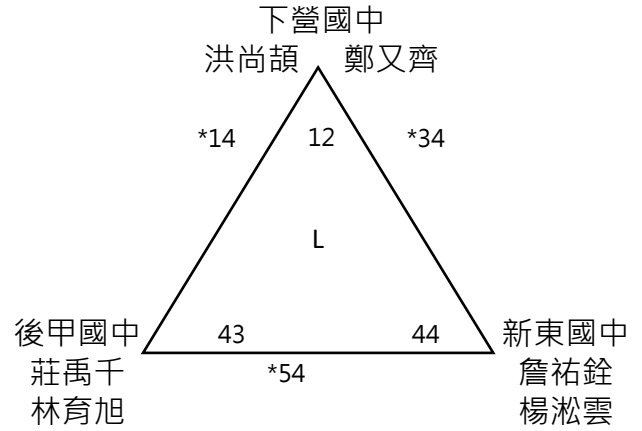
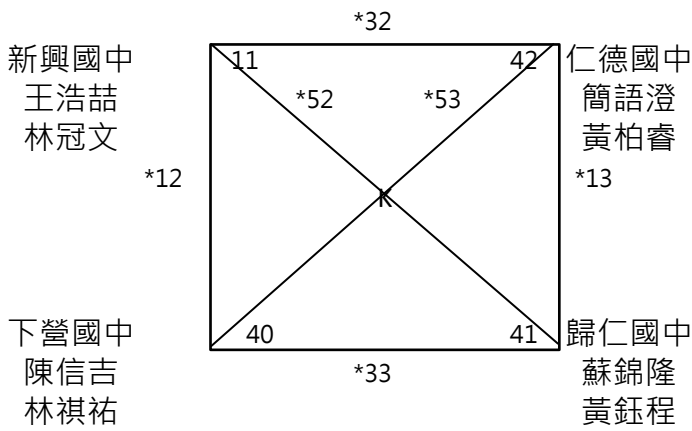
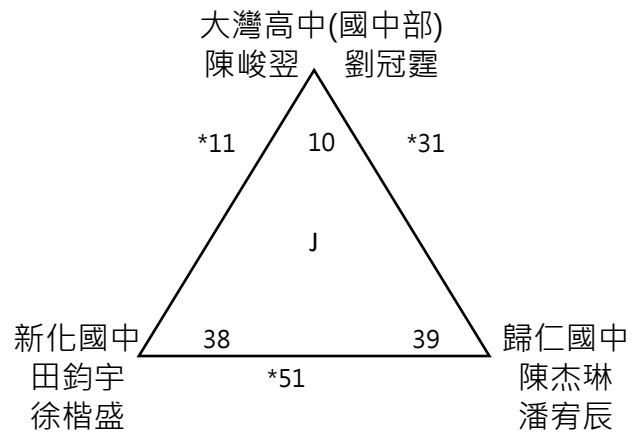
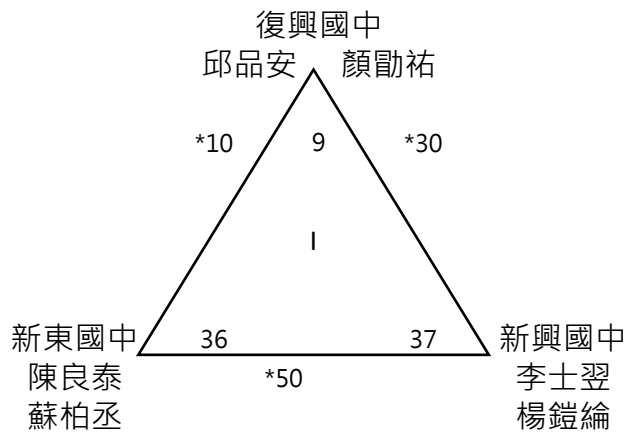

組別 國男雙 預賽

組數 56 小組3取1、4取2

晉級 20

9月22日

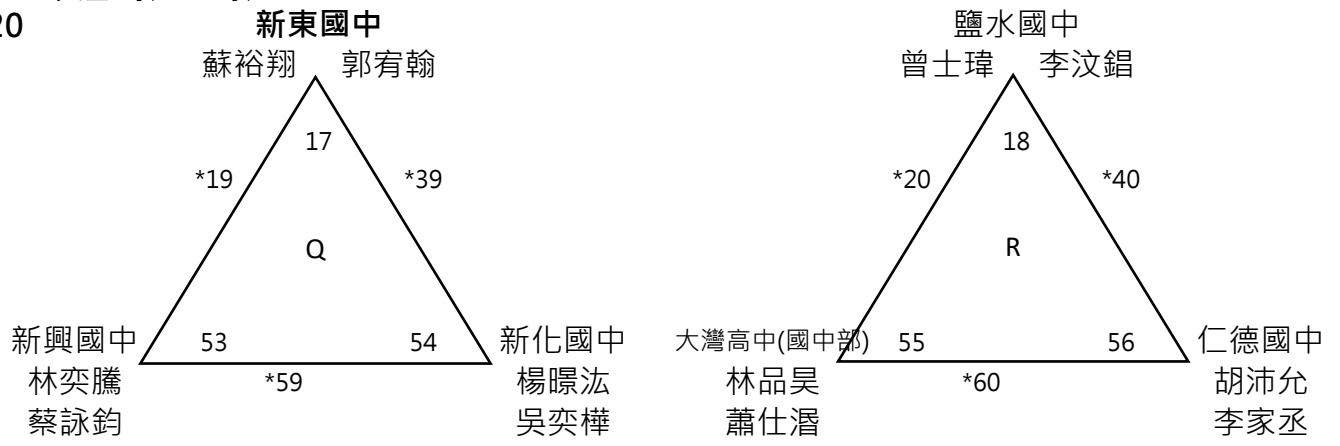

組別: 國男雙決 9月23日
 晉級: 20

籤號

